

# User Guide

# PANTUM

[WWW.PANTUM.COM](http://WWW.PANTUM.COM)

---

## Pantum M6200/M6500/M6550 Series Pantum M6600 Series Monochrome Laser MFP



It is recommended to carefully read this Guide before using the printer

---

# Preface

Welcome to the Pantum series products!

We heartily appreciate your using of Pantum series products!

To protect your vital interests, please carefully read the following statements.

For more information, please visit our official website ([www.pantum.com](http://www.pantum.com)).

## Legal Notice

### Trademark

Pantum and Pantum logos are registered trademarks of Zhuhai Pantum Electronics Co., Ltd.

Microsoft<sup>®</sup>, Windows<sup>®</sup>, Windows Server<sup>®</sup> and Windows Vista<sup>®</sup> are trademarks registered by Microsoft Corporation in the United States or other countries/regions.

Apple, AirPrint and Mac are trademarks of Apple Inc, registered in the U.S. and other countries. Use of the Works with Apple badge means that an accessory has been designed to work specifically with the technology identified in the badge and has been certified by the developer to meet Apple performance standards.

Mopria<sup>®</sup>, the Mopria<sup>®</sup> Logo, and the Mopria Alliance<sup>™</sup> word mark and logo are registered and/or unregistered trademarks and service marks of Mopria Alliance, Inc. in the United States and other countries. Unauthorized use is strictly prohibited.

Wi-Fi Direct, Wi-Fi Protected Setup (WPS), WPA, WPA2, WPA3 and Wi-Fi Protected Access are marks of the Wi-Fi Alliance.

The ownership to the names of the software in this User Guide belongs to their respective companies in accordance with corresponding license agreement, and they are referred for instructions only.

All other product and brand names herein may be the registered trademarks, trademarks or service marks of their respective owners, and they are referred for instructions only.

### Copyright

The copyright of this User Guide is owned by Zhuhai Pantum Electronics Co., Ltd.

It is prohibited to copy, translate, modify and transmit this User Guide by any means or in any form without the prior written consent of Zhuhai Pantum Electronics Co., Ltd.

Version: V2.5

### Disclaimer

For a better user experience, Zhuhai Pantum Electronics Co., Ltd. reserves the right to make changes to the User Guide. The information contained herein is subject to change without notice. Users are responsible for any damages arising from failing to follow this User Guide. Meanwhile, except the express warranty made in the product maintenance manual or service commitment, Zhuhai Pantum Electronics Co., Ltd. does not make any express or implied warranty or guarantee to this User Guide (including composing or words).

Using this product to copy, print, scan certain documents or images or make other forms of operations may be prohibited by the local laws. If you are uncertain about the legality of using this product for certain documents or images, you should consult your legal advisor in advance.

The product can only be used safely in the non-tropical areas at an altitude no higher than 2000 meters.

# Safety Precautions

## Disconnect the power supply

The product should be placed close to or easily accessible to power sockets, so as to allow easy disconnection of power supply!

## Laser Safety

The laser radiation is harmful to the human body. Since laser components are completely sealed in the printer, laser radiation will not leak. To avoid laser radiation, please do not randomly disassemble the printer!

The printer follows the provisions of Class 1 laser products under CFR standard.



The printer has a Class III b laser diode, which has no laser radiation leakage among laser components.

The laser components shall comply with the requirements of: U.S. Code of Federal Regulations, 21 CFR 1040, IEC 60825-1

The following label is attached to the laser components inside the printer:



## Reclamation and recycling

To protect the environment, our corporation has already established the system of reclamation and recycling for waste products. Please refer to the Pantum official website for product recovery at [www.pantum.com](http://www.pantum.com).

## Safety Warning

Please note the following safety warnings before using the printer:



### Warning



There is high-voltage electrode inside the printer. Before cleaning the printer, make sure the power is turned off!

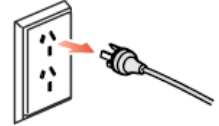

Plugging and unplugging the power cord plug with a wet hand can result in an electric shock.



The fuser unit is hot when and after printing. Touching the fuser unit (the shaded area as shown) may cause burns!

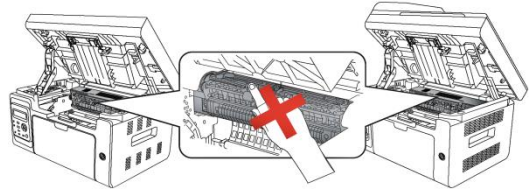

The fuser unit is attached with a high temperature warning label. Please do not remove or damage this label.

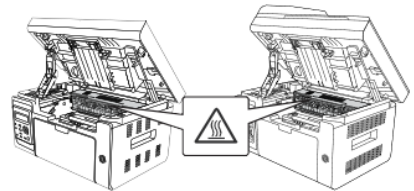

---

# Precautions

## Precautions before Using the Printer:

1. Read and understand all instructions;
2. Familiarize yourself with the basic principles associated with operating electrical appliances;
3. Comply with all warnings and instructions marked on the equipment or specified in the manual supplied with the equipment;
4. If the operating instructions conflict with the safety information, please refer back to the safety information, as you may have misunderstood the operating instructions. If you cannot resolve the conflicts, please call the Customer Service Hotline or contact a service representative for help;
5. Before cleaning the equipment, remove the power cord from the AC power supply outlet. Do not use liquid or aerosol cleaners;
6. Please make sure that the equipment is put on a stable desktop surface to avoid serious damage caused by the falling of the equipment;
7. Do not put the equipment near a radiator, an air conditioner, or a ventilation pipe;
8. Do not put any articles on the power cord. Do not put the equipment at the place where its power cord could be stepped on by people;
9. Outlets and extension cords must not be overloaded. This may reduce performance and could result in fire or electric shock;
10. Do not allow pets to chew on the AC power cord or the computer interface cable;
11. Do not allow sharp objects piercing equipment slot, so as to avoid contact with the high-voltage device, which otherwise may result in fire or electric shock. Take care not to spill liquids onto the equipment;
12. Do not disassemble the equipment so as to avoid the risk of electric shock. Necessary repairs may only be carried out by professional maintenance personnel. Opening or removing the cover could result in an electric shock or other potential hazards. Incorrect disassembly and assembly could also result in an electric shock during future use;
13. If any one of the following occurs, disconnect the equipment from the computer and pull out the power cord from the AC wall socket and contact a qualified member of the service personnel for maintenance:
  - Liquid has been spilled into the equipment.
  - The equipment has been exposed to rain or water.
  - The equipment falls, or the cover is damaged.
  - Significant changes in the equipment's performance.
14. Only adjust the control mentioned in the instructions. Incorrect adjustment of other controls may result in damage and mean that professional maintenance personnel need to spend more time fixing it;
15. Do not use the equipment in a thunderstorm so as to avoid the risk of an electric shock. If possible, pull out the AC power cord during a thunderstorm;
16. If you continuously print multiple pages, the surface of the tray will become very hot. Take care not to touch this surface, and keep children away from this surface;
17. The signal wire of the device connected with the printer can not be connected to the outdoors;
18. Please ensure timely ventilation in case of a prolonged use or printing huge amounts of documents in a poorly ventilated room;

- 
19. In standby status, the product will automatically enter into the power saving (sleep) mode if it does not receive any job order for a while (such as 1 minute); and it can realize zero power consumption only if it has not been connected with any external input power supply;
20. As the Class 1 equipment, the product must be connected to the power supply outlet with protective grounding line when using;
21. This product should be placed according to the shipping marks on the product package box during delivery;
22. This product is a kind of low-voltage equipment. When using this product below the specified voltage range, please refer to the product precautions or call Pantum Aftersales Service Centre, if the toner comes off the printed contents, or the equipment starts slowly;
23. This product is sold as a complete machine. The consumers can go to Pantum Aftersales Service Centre to purchase parts they need. If the product sold is inconsistent with the package list, please go to the specified Aftersales Service Centre to solve the problem;
24. Install this product in a place with the temperature between 10°C and 32.5°C and the relative humidity between 20% and 80%;
25. For security and other reasons the printer may switch to intermittent printing after a certain amount of continuous printing.
26. This device contains Part 15 of the FCC Rules and licence-exempt transmitter(s)/receiver(s) that comply with Innovation, Science and Economic Development Canada's licence-exempt RSS(s). Operation is subject to the following two conditions:
- (1) this device may not cause harmful interference, and
  - (2) this device must accept any interference received, including interference that may cause undesired operation.
27. Radiation Exposure Statement:
- This equipment complies with Canada and FCC radiation exposure limits set forth for uncontrolled environments. This equipment should be installed and operated with a minimum distance of 20cm between the radiator and your body.
- This transmitter must not be co-located or operating in conjunction with any other antenna or transmitter.
28. NOTE: This equipment has been tested and found to comply with the limits for a Class B digital device, pursuant to Part 15 of the FCC Rules. These limits are designed to provide reasonable protection against harmful interference in a residential installation. This equipment generates, uses and can radiate radio frequency energy and, if not installed and used in accordance with the instructions, may cause harmful interference to radio communications. However, there is no guarantee that interference will not occur in a particular installation.
- If this equipment does cause harmful interference to radio or television reception, which can be determined by turning the equipment off and on, the user is encouraged to try to correct the interference by one or more of the following measures:
- Reorient or relocate the receiving antenna.
  - Increase the separation between the equipment and receiver.
  - Connect the equipment into an outlet on a circuit different from that to which the receiver is connected.
  - Consult the dealer or an experienced radio/TV technician for help.
29. Warning: Changes or modifications to this unit not expressly approved by the party responsible for compliance could void the user's authority to operate the equipment.

---

30. The power consumption of the product is 3.137W in networked standby if all wired network ports are connected and all wireless network ports are activated;

31. Shielded cables must be used with this unit to ensure compliance with the Class B FCC limits.

32. This Class B digital apparatus complies with Canadian ICES-003.

33. This equipment complies with Part 68 of the FCC rules and the requirements adopted by the ACTA. On the back of this equipment is a label that contains, among other information, a product identifier in the format US: VFCFA00B66. If requested, this number must be provided to the telephone company. This equipment uses the following USOC jacks: RJ-11, RJ-45, USB jacks and power jacks.

#### 34. REN (RINGER EQUIVALENT NUMBERS) STATEMENT

Notice: The Ringer Equivalence Number(REN: 0.01B) assigned to each terminal device provides an indication of the maximum number of terminals allowed to be connected to a telephone interface. The termination on an interface may consist of any combination of devices subject only to the requirement that the sum of the Ringer Equivalence Numbers of all the devices does not exceed 5.

#### 35. ATTACHMENT LIMITATIONS STATEMENT

Notice: This equipment meets telecommunications network protective, operational and safety requirements as prescribed in the appropriate Terminal Equipment Technical Requirements document(s). This is confirmed by marking the equipment with the Industry Canada certification number. The Department does not guarantee the equipment will operate to the user's satisfaction. Before installing this equipment, users should ensure that it is permissible to be connected to the facilities of the local telecommunications company. The equipment must also be installed using an acceptable method of connection. The customer should be aware that compliance with the above conditions may not prevent degradation of service in some situations.

Repairs to certified equipment should be coordinated by a representative designated by the supplier. Any repairs or alterations made by the user to this equipment, or equipment malfunctions, may give the telecommunications company cause to request the user to disconnect the equipment.

Users should ensure for their own protection that the electrical ground connections of the power utility, telephone lines and internal metallic water pipe system, if present, are connected together. This precaution may be particularly important in rural areas.

Caution: Users should not attempt to make such connections themselves, but should contact the appropriate electric inspection authority, or electrician, as appropriate.

36. This product meets the applicable Industry Canada technical specifications.

37. Please keep this User Guide properly.

---

## Legal Information

---



This symbol indicates that, at the end of your product's life, it must not be discarded as domestic waste. Instead, you should dispose of your used equipment at a designated collection point for the recycling of waste electrical and electronic equipment. Ref: EU Directive 2002/96/EC on Waste Electrical and Electronic Equipment (WEEE). Please contact your distributor / supplier for further information.

---



This product is suitable for indoor use only.

---



European Community (EC) directives conformity

This product complies with the protection requirements of EC directives 2014/30/EU and 2014/35/EU on the approximation and harmonization of the laws of the Member States relating to electromagnetic compatibility and safety of electrical equipment designed for use within certain voltage limits.

Radio Equipment directive 2014/53/EU only for models ending with suffix "W".

The manufacturer of this product is: Zhuhai Pantum Electronics Co., Ltd., Building 02,06 and 08, No.888 Shengping Avenue, Pingsha Town, Zhuhai City, Guangdong Province, 519000 PR China.

A declaration of conformity to the requirements of the Directives is available upon request from the Authorized Representative.

This product satisfies the Class B limits of EN 55032 / EN 55035 and safety requirements of EN 62368-1.

---



This printer is fully compliant with the ROHS Directive 2009/95/EC and the requirements of the revised Directive 2011/65/EU for managing toxic and hazardous substances.

---



A battery is built in the product with the faxing feature. When the product battery is scraped, it should never be disposed with other household waste. In order to protect the natural resources and promote the reuse of materials, please separate the battery from other types of waste, and deliver it to your local battery recycling systems for recycling.

---

Warning: 1. The battery of this product is non-rechargeable, and it should never be dismantled, crushed, heated or burned. Improper replacement operations may cause fire and burns; 2. The battery should be placed beyond the reach of children to prevent them swallowing.

---





To protect natural resources and promote the utilization of materials, please separate the battery from other types of waste for recycle by your local battery recovery system.



Warning: 1. The battery of this product is non-rechargeable, and it should never be dismantled, crushed, heated or burned. Improper replacement operations may cause fire and burns; 2. The battery should be placed beyond the reach of children to prevent them swallowing.

SVHC (Substances of Very High Concern) content stated in REACH Regulation: Battery built in the equipment with faxing feature contains SVHC including: 1,2-dimethoxyethane;ethylene glycol dimethyl ether (EGDME) with concentration of 0.707%.

---

---

# Table of Contents

1. Before Using the Printer .....	1
1.1. Introduction of Models .....	1
1.2. Supplied Accessories .....	2
1.3. Product View .....	3
1.4. Laser Toner Cartridge .....	6
1.5. Easily-Refilled Laser Toner Cartridge .....	7
1.5.1 Structure of Easily-Refilled Laser Cartridge.....	7
1.5.2. Steps of Filling the Easily-Refilled Laser Cartridge.....	7
1.6. Control Panel .....	9
2. Paper and Print Media .....	12
2.1. Paper Specification .....	12
2.2. Special Paper.....	13
2.3. Non-printing Area and Non-scanning Area .....	14
2.4. Load the Paper.....	15
2.5. Paper and Manuscript Use Process .....	16
2.5.1. Scanning With Tablet .....	16
2.5.2. Scanning With Tablet .....	18
3. Driver installation and uninstallation .....	19
3.1. Driver Setup .....	19
3.1.1. One-click Installation(For Windows and macOS) .....	19
3.1.2. More setup methods .....	33
3.2. Uninstall Driver .....	46
3.2.1. Method to uninstall driver under Windows.....	46
3.2.2. Method to uninstall driver under macOS .....	46
4. Wired Network Settings (For printer models that support wired network printing).....	47
4.1. Install the Printer to Network .....	47
4.2. Control the Network Printer .....	47
4.2.1. View or Change Network Settings.....	47
4.2.2. Set or Change Web Server Login Password .....	48
4.2.3. SNMP protocol setup .....	48
5. Wireless network setup (applicable to Wi-Fi models) .....	49
5.1. Basic structure mode.....	49
5.1.1. Wireless network setup tools.....	50
5.1.2. Wi-Fi Protected Setup (WPS) setup .....	54
5.1.3. How to disable the Wi-Fi network connected.....	55
5.2. Wi-Fi hotspot mode .....	55
5.2.1. Preliminary preparations .....	55

5.2.2. Wi-Fi Hot Connection .....	55
5.2.3. Wi-Fi Hotspot Configuration .....	55
5.3. Wireless network setup FAQs .....	56
6. Mobile Print/Scan/Fax (for models with Wi-Fi function only) .....	57
6.1. "Pantum" APP .....	57
6.1.1. Operating systems supported .....	57
6.1.2. How to download Pantum APP .....	57
6.1.3. How to use this "Pantum" APP.....	57
6.2. Mopria mobile print.....	58
6.2.1. The operating systems and applications which support Mopria mobile printing.	58
6.2.2. How to download Mopria Print Service.....	58
6.2.3. Preliminary preparations .....	58
6.2.4. How to use Mopria mobile printing .....	59
6.3. AirPrint mobile print.....	59
6.3.1. Operating systems supported by AirPrint mobile print .....	59
6.3.2. Preliminary preparations .....	59
6.3.3. How to use AirPrint mobile printing .....	60
7. General Settings .....	61
7.1. System Settings .....	61
7.1.1. Toner Save Setting .....	61
7.1.2. Language Setting.....	62
7.1.3. Restore to Factory Settings.....	63
7.1.4. Sleep Time Setting.....	64
7.1.5. Auto shut-off setting .....	65
7.2. Network Settings .....	66
7.3. Network Information .....	67
7.4. Information report.....	68
8. Print .....	69
8.1. Print Function .....	69
8.2. Open Help Document.....	70
8.3. Duplex Print .....	71
8.4. Cancel Print Job.....	74
8.5. macOS System Print.....	74
9. Copying.....	80
9.1. Copying function .....	80
9.2. Copying method .....	80
9.3. Copying cancel.....	80
9.4. Common copying setting.....	81
9.4.1. Image quality .....	81

9.4.2. Intensity .....	81
9.4.3. Resizing .....	81
9.4.4. Multipage .....	82
9.4.5. Clone .....	82
9.4.6. Poster .....	83
9.4.7. Collated copy .....	83
9.4.8. Manual dual-side.....	84
9.4.9. Paper setting.....	84
9.5. ID card copying setting.....	84
9.5.1. Arrangement mode .....	85
9.5.2. Intensity .....	85
9.5.3. Paper setting.....	85
9.6. Receipt setting .....	86
9.6.1. Intensity .....	86
9.6.2. Paper setting.....	86
10. Scan .....	87
10.1. Push Scan.....	87
10.1.1. Steps for Push Scan with Tablet .....	87
10.1.2. Steps for Push Scan with Automatic Document Feeder(ADF).....	88
10.1.3. Single Page Scan .....	88
10.1.4. Merge Scan .....	88
10.1.5. Other Scan Functions .....	90
10.2. Pull Scan.....	94
10.2.1. Pantum Scan Application .....	94
10.2.2. TWAIN Scan Driver.....	95
10.2.3. WIA Scan Driver .....	97
10.2.4. Cancel Scan Job.....	101
10.3. macOS System Scan .....	102
10.3.1. ICA Scan.....	102
10.3.2. TWAIN Scan .....	106
11. Fax.....	107
11.1. Connect Devices .....	107
11.2. Fax Settings .....	107
11.3. Fax Functions.....	110
11.3.1. Send Fax .....	110
11.3.2. Receive Fax.....	113
11.3.3. Other Scan Functions .....	114
11.4. Contacts.....	120
11.5. Cancel Fax.....	121

---

11.6. Pantum PC-Fax Software.....	121
11.6.1. Open With.....	121
11.6.2. Sending Fax with PC-Fax.....	122
11.6.3. Basic Settings for PC-Fax .....	123
11.6.4. Other Functions for Sending Fax with PC-Fax .....	124
12. Routine Maintenance .....	126
12.1. Cleaning the Printer.....	126
12.2. Maintenance of Laser Toner Cartridge .....	129
12.2.1. Use and Maintenance of Laser Toner Cartridge.....	129
12.2.2. Service Life of the Laser Toner Cartridge.....	129
12.2.3. Replace Laser Toner Cartridge .....	130
13. Troubleshooting .....	133
13.1. Clearing Jammed Paper.....	133
13.2. Error Message.....	136
13.3. Common Troubleshooting .....	137
13.3.1. Common Trouble .....	137
13.3.2. Image Defects.....	139
14. Menu Structure .....	142
15. Product Specifications.....	143
15.1. Overview of the Specifications.....	143
15.2. Print Specifications.....	144
15.3. Copy Specifications.....	144
15.4. Scan Specifications .....	144
15.5. Fax Specifications (For M6600 Series models only) .....	145

# 1. Before Using the Printer





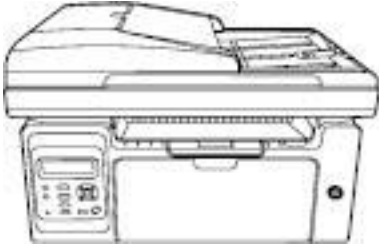
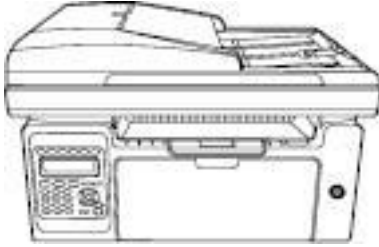

## 1.1. Introduction of Models

This product have the following configurations:

<b>Series Name</b>	<b>M6200/M6500 Series</b>
<b>Picture</b>	
<b>Basic Functions</b>	Print, Copy, Scan
<b>Basic Models</b>	USB Model, NET Model, Wi-Fi Model
<b>Basic Specifications</b>	<ul style="list-style-type: none"> <li>• The maximum print speed of A4 paper is 20/22ppm, and that of letter paper is 21/23ppm.</li> <li>• The maximum volume of feeder tray is 150 pages and the maximum volume of output tray is 100 pages.</li> <li>• Support full-color scanning.</li> <li>• Support the function of scanning to email.</li> </ul>

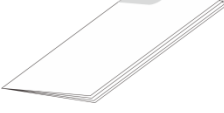
<b>Series Name</b>	<b>M6550 Series</b>	<b>M6600 Series</b>
<b>Picture</b>		
<b>Basic Function</b>	Print, Copy, Scan, Fax	
<b>Basic Models</b>	USB Model, NET Model, Wi-Fi Model	
<b>Basic Specifications</b>	<ul style="list-style-type: none"> <li>• The maximum print speed of A4 paper is 22ppm, and that of letter paper is 23ppm.</li> <li>• Support scan for automatic document feeder.</li> <li>• The maximum volume of feeder tray is 150 pages and the maximum volume of output tray is 100 pages.</li> <li>• Support full-color scanning.</li> <li>• Support the function of scanning to email.</li> <li>• Support Fax function (Only M6600 Series).</li> </ul>	

## 1.2. Supplied Accessories

Name	
USB Interface Cable	
Power Cord	
CD-ROM	
Quick Setup Guide	
Pantum Warranty	
Phone	
Phone Cord	
Spiral Cable	

 **Note:** • The Pantum Warranty may not be attached in some regions.  
• M6600 Series come with phone, phone cord and spiral cable in some countries.  
• Volume control is not available with the phone.

## 1.3. Product View

### | Side view (1)

---

#### No. M6200/M6500 Series

---

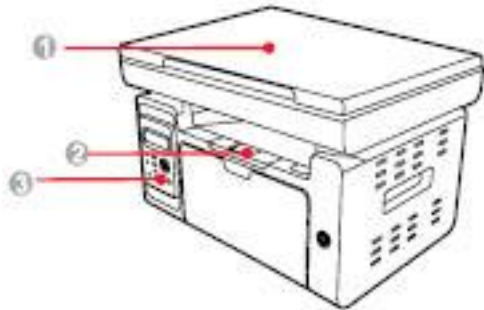

---

1 Cover

---

2 Output Bin

---

3 Control Panel

---

#### No. M6550/M6600 Series

---



---

1 Automatic document feeder

---

2 Cover

---

3 Output Bin

---

4 Control Panel

---



## | Side view (2)

---

**No. M6200/M6500 Series**

---

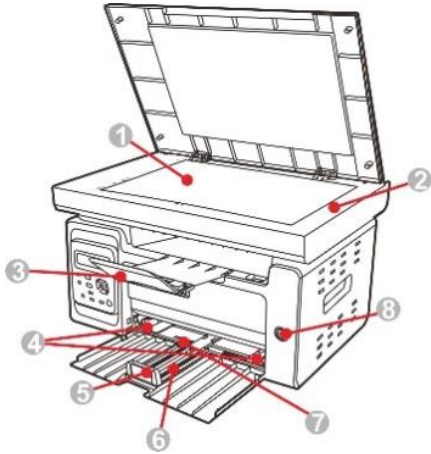

- 
- |   |                                |
|---|--------------------------------|
| 1 | Glass Platen                   |
| 2 | Scanning Platform              |
| 3 | Output Tray                    |
| 4 | Automatic Feed Paper Deflector |
| 5 | Paper Stop                     |
| 6 | Feeder Tray                    |
| 7 | Automatic Feeder Tray          |
| 8 | Power switch                   |
- 

---

**No. M6550/M6600 Series**

---

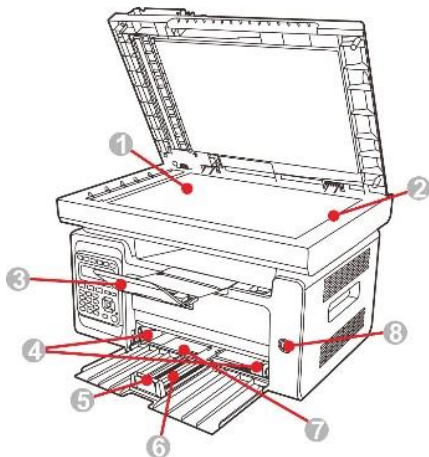

- 
- |   |                                |
|---|--------------------------------|
| 1 | Glass Platen                   |
| 2 | Scanning Platform              |
| 3 | Output Tray                    |
| 4 | Automatic Feed Paper Deflector |
-

5	Paper Stop
6	Feeder Tray
7	Automatic Feeder Tray
8	Power switch

- 
-  **Note:**
- The power switch of the printer is divided into two types: “touch type” and “self-locking type”. The actual appearance of the purchased printer will prevail.
  - The “touch type” power switch of the printer only has one mode, and can be reset by short-pressing.
    - 1) ON: short-press the power switch in the OFF state to turn on the power supply of the printer.
    - 2) OFF: long-press the power switch for about 3s in the ON state to turn off the power supply of the printer.
  - The “self-locking type” power switch of the printer has two modes: lock and disconnect.
    - 1) ON: short-press the power switch in the OFF state to turn on the power supply of the printer.
    - 2) OFF: short-press the power switch in the ON state to turn off the power supply of the printer.
- 

## | Rear View

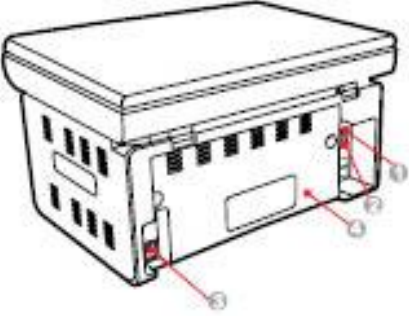
No.	M6200/M6500 Series
	
1	USB Interface
2	Network Interface
3	Power Interface
4	Rear Cover

---

**No. M6550/M6600 Series**

---

Diagram



- 
- |   |  |
|---|--|
| 1 | USB Interface                                |
| 2 | Network Interface                            |
| 3 | Extension Interface (For M6600 Series only)  |
| 4 | Phone Cord Interface (For M6600 Series only) |
| 5 | Rear Cover                                   |
| 6 | Power Interface                              |
- 

 **Note:** • The diagram may vary slightly with different models and functions.

---

## 1.4. Laser Toner Cartridge

### | Service Life of the Laser Toner Cartridge



---

Type	Average Print Volume
Laser Toner Cartridge with Standard Capacity	About 1600 Pages (The above data is based on ISO/IEC 19752 standard)

---

 **Note:** • The model is subject to increase without notice.

- Consumables capacity may vary with different using types.
- It's not recommend using consumables other than the original Pantum consumables.
- Any damages caused by using non-Pantum original consumables are not covered by the Warranty.

---

# 1.5. Easily-Refilled Laser Toner Cartridge

## 1.5.1 Structure of Easily-Refilled Laser Cartridge



No.	Name
1	Waste Toner Port
2	Toner Refilling Port
3	Waste Toner Box
4	Toner Box

## 1.5.2. Steps of Filling the Easily-Refilled Laser Cartridge

Steps	Diagram	Description
1	A diagram showing the cartridge held vertically. A downward-pointing arrow is next to the text '5-6x', indicating the shaking action.	Hold the laser toner cartridge with the toner port side down and shake it vertically around 5-6 times.
2	A diagram showing the cartridge with the cover of the waste toner port being lifted away from the bottom-left side.	Open the cover of the waste toner port.
3	A diagram showing the waste toner box being tilted to the right, with a small amount of toner being poured out.	Pour out the waste toner from the waste toner box.
4	A diagram showing the cover of the waste toner port being pushed back into place and closed.	Close the cover of the waste toner port.
5	A diagram showing the cartridge with the cover of the toner refilling port being lifted away from the bottom-left side.	Open the cover of the toner refilling port.



6

Align the mouth of the toner bottle to the toner refilling port.

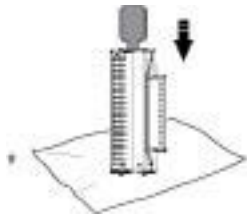

7

Pour the toner into the toner box.



8

Close the cover of the toner refilling port.



9

The toner refilling is completed.

---

## 1.6. Control Panel

### M6200/M6500/M6550 Series

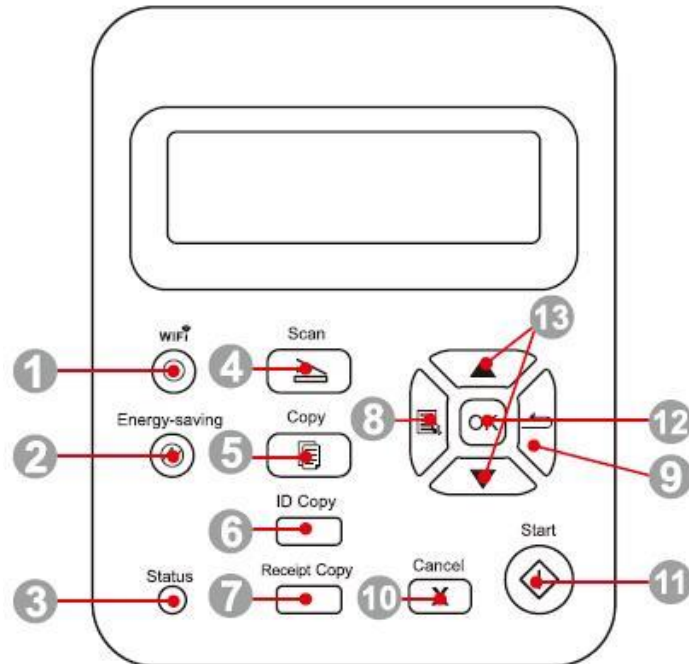

1	Wi-Fi button	<p>Short press Wi-Fi button to turn on direct Wi-Fi connection of the printer and automatically print out "Mobile Device Wi-Fi Connection Wizard" page (for models with Wi-Fi function only).</p> <p>Long press Wi-Fi button for over 2s to start WPS when Wi-Fi is not connected or to disconnect Wi-Fi when it has already been connected (for models with Wi-Fi function only).</p> <p>Open save toner function (applicable to non-Wi-Fi model only).</p>
2	Power Saving/Wake-up Button	<p>Press this button to switch to power saving status or wake the machine from power saving status</p>
3	Status Light	<p>This light indicates the ready, alarm and other status of the printer</p> <p>Green light: Normal</p> <p>Orange light: Warning</p> <p>Red Light: Error</p>
4	Scan Button	<p>Press this button to enter into scan mode</p>
5	Copy Button	<p>Press this button to enter into copy mode</p>
6	ID Card Copy Button	<p>Press this button to enter into ID Card Copy mode</p>
7	Bill Copy Button	<p>Press this button to enter into Bill Copy mode</p>
8	Menu Button	<p>Press this button to access the menu options to make the settings</p>
9	Back Button	<p>Press this button to go back to the upper-level page</p>

10	Cancel Button	Press this button to cancel the operation
11	Start Button	Press this button to start the corresponding operation after the operation setting
12	OK Button	Press this button to save the setting
13	“▲” and “▼”	Press these two buttons to browse each menu and its options

## M6600 Series

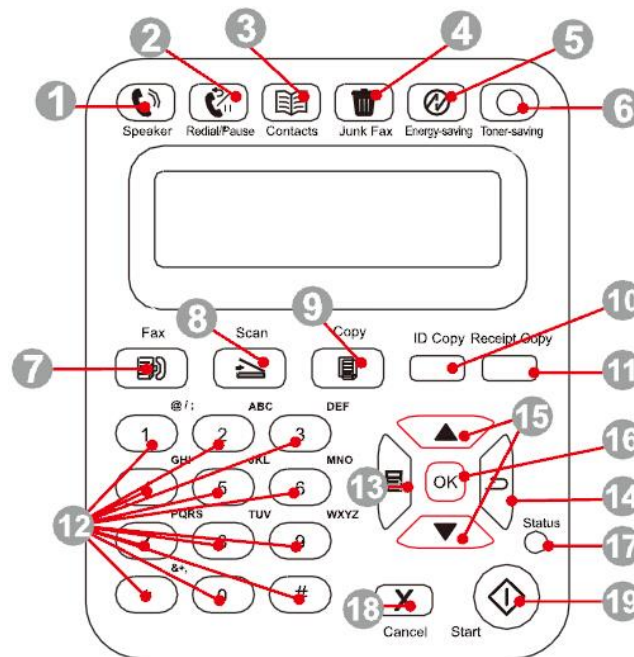

1	Speaker	Press this button, enter the number to dial, and then press the Start button to Fax.
2	Redial/Pause	This button allows you to redial the last number you dialed or insert pause when you set up speed dial or dial manually.
3	Contacts	This button allows you to dial the speed dial number directly.
4	Junk Fax	When you receive a Fax, press this button to add the currently received Fax number to the junk Fax number list;
5	Power Saving/Wake-up Button	Press this button to switch to power saving status or wake the machine from power saving status
6	Wi-Fi Button	Short press Wi-Fi button to turn on direct Wi-Fi connection of the printer and automatically print out "Mobile Device Wi-Fi Connection Wizard" page (for models with Wi-Fi function only). Long press Wi-Fi button for over 2s to start WPS when Wi-Fi is not connected or to disconnect Wi-Fi when it has already been connected (for models with Wi-Fi function only). Open save toner function(applicable to non-Wi-Fi model only).

7	Fax	Press this button to enter into the Fax mode.
8	Scan Button	Press this button to enter into the scan mode
9	Copy Button	Press this button to enter into the copy mode
10	ID Card Copy Button	Press this button to enter into the ID card copy mode
11	Bill Copy Button	Press this button to enter into the bill copy mode
12	Number Buttons	You can use these buttons to dial a phone or Fax number, or use them as a keyboard for input into the device.
13	Menu Button	Press this button to access the menu options to make the settings.
14	Back Button	Press this button to go back to the upper-level page
15	“▲” and “▼”	Press this button to browse through each menu and its options
16	OK Button	Press this button to save the settings
17	Status Light	This light indicates the ready, alarm or other statuses of the printer Green light: Normal Orange light: Warning Red light: Error
18	Cancel Button	Press this button to cancel the operation
19	Start Button	Press this button to start the corresponding operation after the operation is set.



## 2. Paper and Print Media

### 2.1. Paper Specification

---

	Media Type	Plain paper, thick paper, transparent film, carton paper, label paper, envelope, thin paper
<b>M6200/M6500/ M6550/M6600 Series</b>	Media size	A4, A5, A6, JIS B5, ISO B5, B6, Letter, Legal, Executive, Statement, Monarch envelope, DL envelope, C5 envelope, C6 envelope, NO.10 envelope, Japanese Postcard, Folio, Oficio, Big 16k, 32k, 16k, Big 32k, ZL, Yougata4, Postcard, Younaga3, Nagagata3, Yougata2, Custom
	Media weight	60~163g/m <sup>2</sup>
	Feeder tray volume	150 pages
	Output tray volume	100 pages

---



- Note:**
- It is recommended to use the standard paper and recycled paper for the printer.
  - It is not recommended to use special paper extensively, which may affect the service life of the printer.
  - The print media that does not meet the guidelines listed in this User Guide may result in poor print quality, increased paper jam and excessive wear of the printer.
  - Properties such as weight, composition, texture and humidity are important factors affecting the printer performance and output quality.
  - Please note the following matters when selecting the print media:
    1. Desired print effect: The print media selected should meet the requirement of the print tasks.
    2. Surface smoothness: The smoothness of the print media may affect the sharpness of the print outcome.
    3. Some print media may meet all the use guidelines contained herein, but they still can not bring satisfactory effect. This may be due to incorrect operation, inappropriate temperature and humidity, or other factors beyond the control of Pantum. Before purchasing large quantities of print media, make sure that the print media meets the specifications specified in this User Guide.
    4. Using print media that does not meet these specifications may cause damage to the printer.
-

## 2.2. Special Paper

This printer supports using the special paper for printing. Special paper includes: label paper, envelope, transparent film, thick paper, thin paper, etc.

- 
-  **Note:** • When using special paper or print media, be sure to select matched print type and size in the print settings so as to get the best print effect.
- When using special media to print, it is recommended to load one piece of paper at one time.
- 

| Please observe the following standards:

<b>Types of Print Media</b>	<b>Correct Practices</b>	<b>Incorrect Practices</b>
Label Paper	Use labels with no exposed lining paper only. Labels shall be put flat when using. Use labels of full sheet only. There is no guarantee that all the labels in the market can meet corresponding requirements.	Use wrinkled, blistered or damaged label papers.
Envelope	Envelopes should be loaded evenly.	Use wrinkled, nicked, stuck or damaged envelopes. Use envelopes with clips, snaps, windows, or coated linings. Use envelopes with self-adhesive stickers or other synthetic materials.
Transparent Film	Only use transparent films approved for use in laser printers.	Use transparent print media that is not suitable for laser printers.
Thick Paper	Only use heavy paper that is approved for use in laser printers and meets the weight specifications of this printer.	Use the paper whose weight is more than the specification of the media recommended for this printer, unless the paper is approved for use in this printer.

## 2.3. Non-printing Area and Non-scanning Area

The shaded part indicates the non-printing area and non-scanning area.

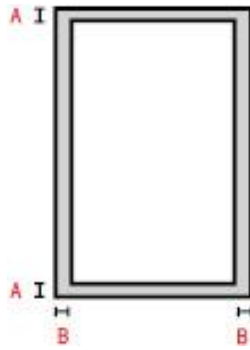

Usage	Paper Size	Top and Bottom Margins (A)	Left and Right Margins (B)
Print	A4	5 mm (0.197 inch)	5 mm (0.197 inch)
	Letter	5 mm (0.197 inch)	5 mm (0.197 inch)
Copy	A4	5 mm (0.197 inch)	5 mm (0.197 inch)
	Letter	5 mm (0.197 inch)	5 mm (0.197 inch)
Scan	A4	5 mm (0.197 inch)	5 mm (0.197 inch)
	Letter	5 mm (0.197 inch)	5 mm (0.197 inch)

## 2.4. Load the Paper

Steps are as follows:

a) Open the feeder tray.

**M6200/M6500/M6550 Series**

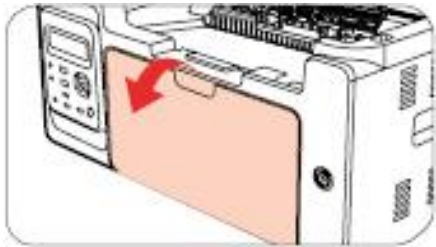

**M6600 Series**

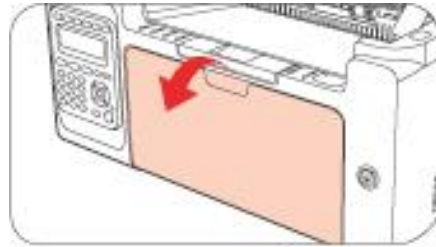

b) Slide the automatic feed guides to match both sides of the paper.

**M6200/M6500/M6550 Series**

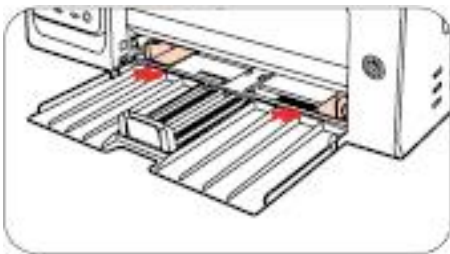

**M6600 Series**

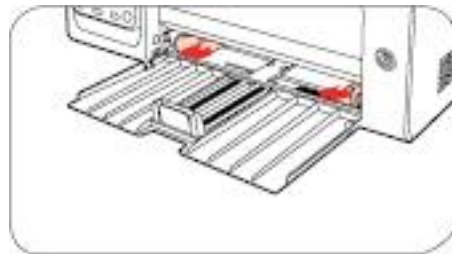

c) Raise the output tray to avoid the paper from slipping and falling.

**M6200/M6500/M6550 Series**

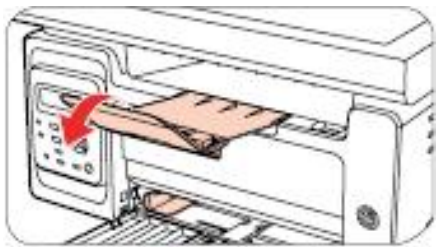

**M6600 Series**

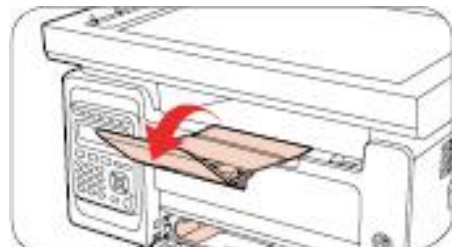

d) Load the paper into the automatic feeder tray with the print-side up.

**M6200/M6500/M6550 Series**

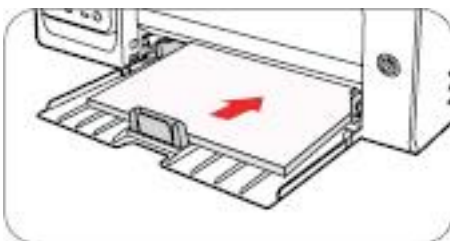

**M6600 Series**

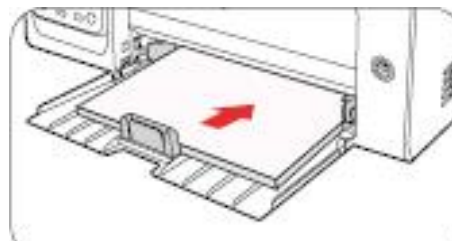

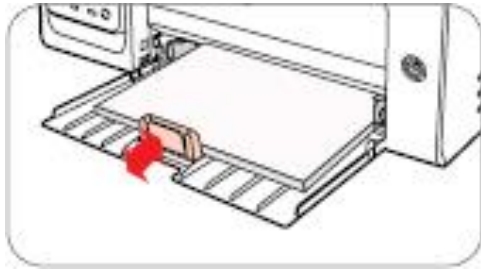

e) Adjust the paper stop to match the paper size.

**M6200/M6500/M6550 Series**

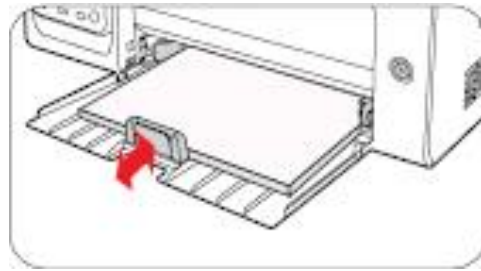

**M6600 Series**



-  **Note:** • If the paper loaded into the automatic feeder tray at one time exceeds 150 pages, paper will jam or cannot be fed in.
- When using the printed paper, please make the side to be printed (the blank side) up.
  - When printing on A5 paper, it is recommended that the paper is fed in landscape orientation, which can extend the service life of the laser toner cartridge.

 **Warning**

 After printing, please immediately remove the paper, envelopes or transparent film paper. Stacking paper or envelopes may cause a paper jam or the paper curling.

## 2.5. Paper and Manuscript Use Process

Manuscript requirements:

Type	Size
Plain paper, thick paper, transparent film, carton paper, label paper, envelope, thin paper	A4, A5, B5, Letter, Custom

### 2.5.1. Scanning With Tablet

Steps of Use:

1. Raise the cover.

**M6200/M6500 Series**

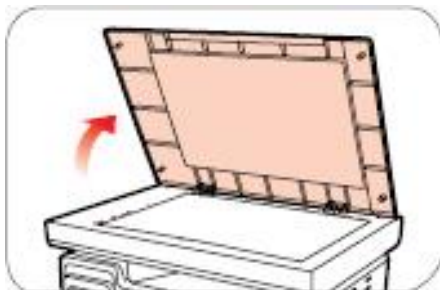

**M6550/M6600 Series**

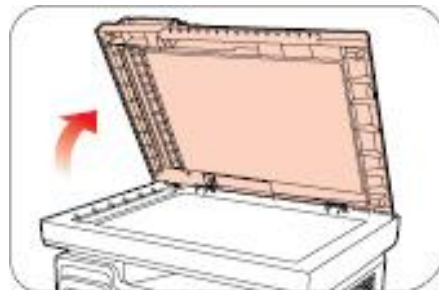

2. Load the manuscript face down.

**M6200/M6500 Series**

**M6550/M6600 Series**

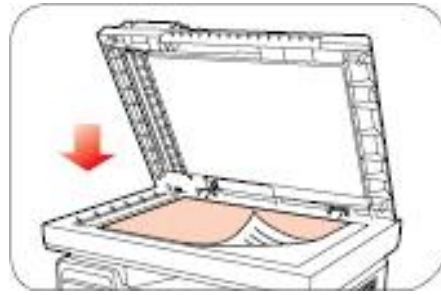

3. Align the manuscript to match the appropriate paper size.

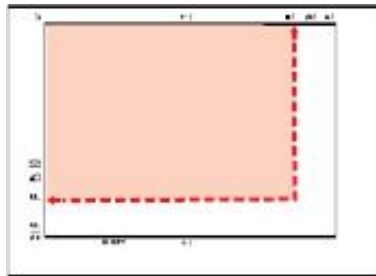



 **Note:** • If the manuscript does not match with any size marker, please align the upper-left corner of the manuscript with the arrow.

4. Gently put down the cover.

**M6200/M6500 Series**

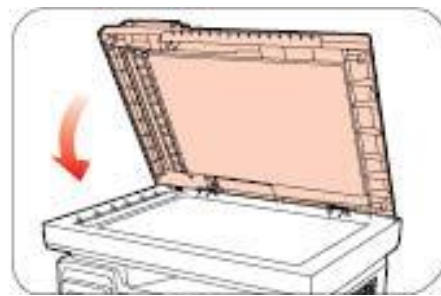
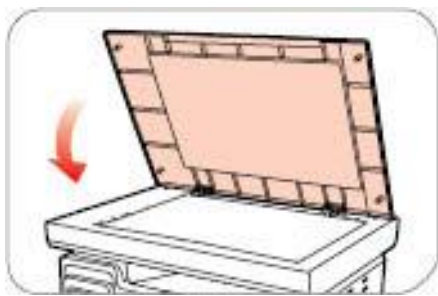
**M6550/M6600 Series**



 **Note:** • Please put the paper or document on the scanner glass after the glue, ink or correction fluid are completely dried.  
• Paper or manuscript with rough texture, concave and convex, oil stain and good smoothness has poor printing performance.  
• Please make sure that there is no dust, fluff, etc. on the paper.  
• Paper shall be put on a flat surface and stored under a cool and dry environment.

## 2.5.2. Scanning With Tablet

(For M6550/M6600 series only)

1. Open the manuscript support flap of the automatic document feeder.



2. Load the manuscript into the automatic document feeder with the front-side up and the top of the manuscript entering into the feeder first.



---

 **Note:** • The automatic document feeder can be loaded up to 35 sheets of paper and supports only feeding paper individually.

---

## 3. Driver installation and uninstallation

### 3.1. Driver Setup

This device supplies driver setup applications for Windows and macOS. We recommend One-click installation, which helps you install the driver automatically in a faster and easier way. Should you encounter trouble when using the One-click installation, you may try more setup methods.

---

 **Note:** • Driver installation interface may differ because of different models and functions, so the schematic diagram is only for your reference.

---

#### 3.1.1. One-click Installation(For Windows and macOS)

One-click installation offers installation options via "Wi-Fi", "USB", and "Wired Network". You may select the one you're familiar with the most according to the connection methods supported by your printer.

##### 3.1.1.1. Connect printer via Wi-Fi

Before installing printer driver, please check if your printer is connected to the Wi-Fi properly. If not, please follow [Section 3.1.1.1.1](#) for installation; and if yes, please follow [Section 3.1.1.1.2](#) for installation.

---

 **Note:** • You can print "Network configuration page" to confirm printer network connection status to see if printer is connected with network (Please see [Section 7.4](#) for how to print).

---

##### 3.1.1.1.1. Printer not connected to Wi-Fi

###### 3.1.1.1.1.1. Configure Wi-Fi and install driver via USB cable

In this section, setup will be introduced in "PC connected to router via Wi-Fi" and "PC connected to router via cable".

---

 **Note:** • Printer Wi-Fi configuration only supports 2.4 GHz networks.

---

#### I. Connect computer to router via Wi-Fi

1. Computer is already connected to router via Wi-Fi.
2. Connect the printer to computer via USB cable, then power the printer on.
3. Place the attached installation CD in the computer CD-ROM:

For Windows:

- Windows XP system: automatically run the installation procedure.
- Windows 7/Vista/Server 2008 system: Pop up "Autoplay" interface, click "Setup.exe" to run the installation procedure.
- Windows 8 system: When the "DVD RW driver" window pops up from the right top corner of computer desktop, click anywhere in the pop-up window, then click "Setup.exe" to run the installation procedure.



- Windows 10/11 system: When the "DVD RW driver" window pops up from the right top corner of computer desktop, click anywhere in the window, then click "Setup.exe" to run the installation procedure.

---

 **Note:** • Some computers may be unable to auto play the CD because of system configuration. Please double click "Computer" icon, find "DVD RW driver", then double click "DVD RW driver" to run the installation procedure.

---

For macOS:

- Double-click on "Pantum XXX Series\_Mac\_Driver" - "Pantum Install Tool". (The XXX in Pantum XXX Series refers to product model.)
4. Read and agree to the terms contained in the End User License Agreement and the Privacy Policy, click the "Next" button in the lower right corner of the interface to enter the driver installation interface.
  5. For Windows, follow Step 6. For macOS, enter PC password before proceeding to Step 6.
  6. Click on "One-click installation" button under Wi-Fi to install the driver.

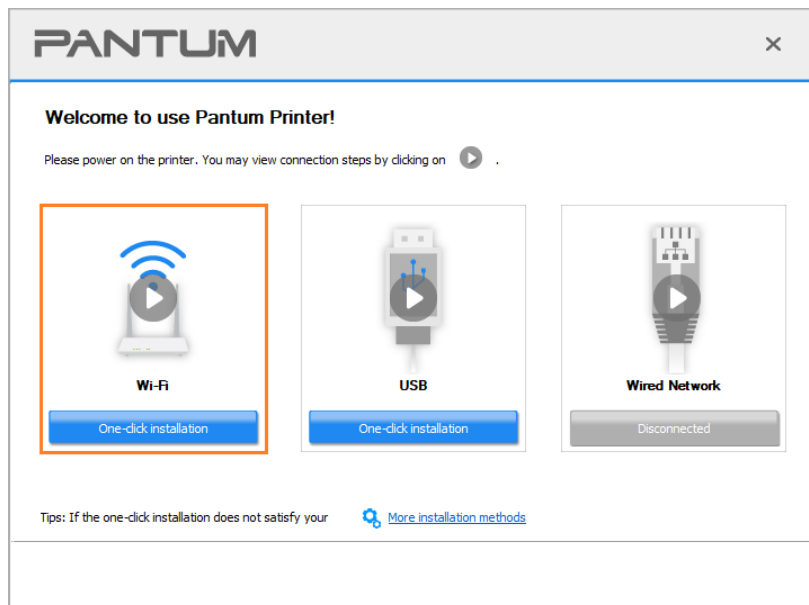

---

 **Note:** • You can put your mouse cursor in the "One-click installation" button to check the popup information in order to confirm if the current printer is the one you need to install through IP address before you click the button.

- You can check the printer IP address through "Network configuration page" (Please see [Section 7.4](#) for how to print)

---

- If the Install Tool finds only one printer, it will proceed to network configuration and driver installation automatically when you click on "One-click installation" under Wi-Fi. (For macOS, authorization is required before printer Wi-Fi can be configured.)

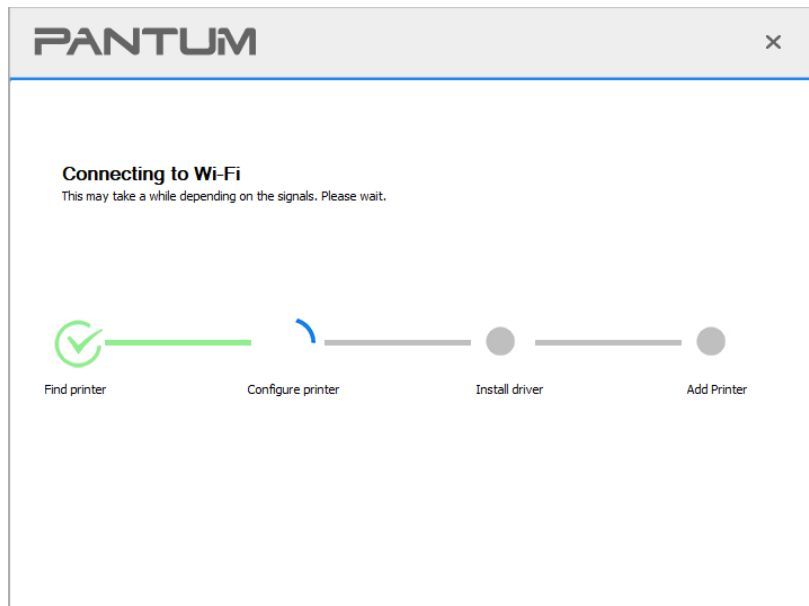

- If the Install Tool finds more than one printer, a printer list will pop up when you click on "One-click installation" under Wi-Fi. You need to select "Configure printer Wi-Fi and install via USB cable", check USB printer, and click on "OK", so the Tool can proceed to network configuration and driver installation automatically. (For macOS, authorization is required before printer Wi-Fi can be configured.)

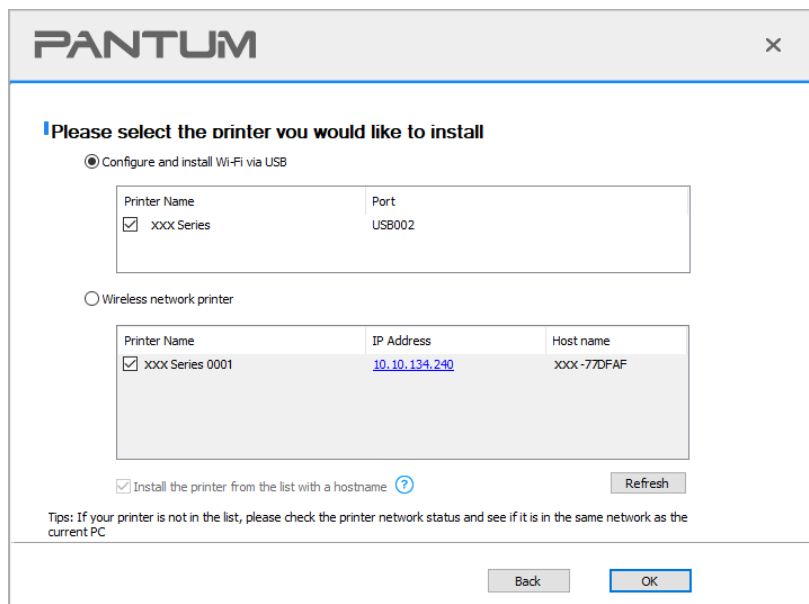

 **Note:** • When the printer IP address changes under printer driver installed with host ID , you can also directly print without re-installing the driver. If you need to install the printer driver with the host ID, please check the option "Install the printer in the list with host ID".

7. After the installation, click "Print & Test Page" button. If your printer prints the test page successfully, it means that you have installed the driver correctly.

## II. Connect computer to router via network cable

1. Connect computer to router via network cable.
2. Connect the printer to computer via USB cable, then power the printer on.
3. Place the attached installation CD in the computer CD-ROM:

For Windows:

- Windows XP system: automatically run the installation procedure.
- Windows 7/Vista/Server 2008 system: Pop up "Autoplay" interface, click "Setup.exe" to run the installation procedure.
- Windows 8 system: When the "DVD RW driver" window pops up from the right top corner of computer desktop, click anywhere in the pop-up window, then click "Setup.exe" to run the installation procedure.
- Windows 10/11 system: When the "DVD RW driver" window pops up from the right top corner of computer desktop, click anywhere in the window, then click "Setup.exe" to run the installation procedure.

---

 **Note:** • Some computers may be unable to auto play the CD because of system configuration. Please double click "Computer" icon, find "DVD RW driver", then double click "DVD RW driver" to run the installation procedure.

---

For macOS:

- Double-click on "Pantum XXX Series\_Mac\_Driver" - "Pantum Install Tool". (The XXX in Pantum XXX Series refers to product model.)
4. Read and agree to the terms contained in the End User License Agreement and the Privacy Policy, click the "Next" button in the lower right corner of the interface to enter the driver installation interface.
  5. For Windows, follow Step 6. For macOS, enter PC password before proceeding to Step 6.
  6. Click on "One-click installation" button under Wi-Fi to install the driver.

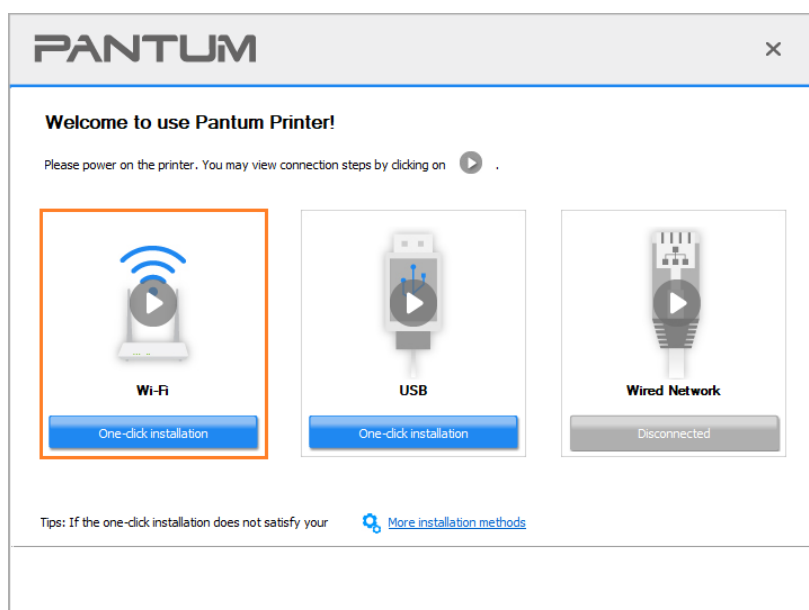



**Note:**• You can put your mouse cursor in the "One-click installation" button to check the popup information in order to confirm if the current printer is the one you need to install through IP address before you click the button.

• You can check the printer IP address through "Network configuration page" (Please see [Section 7.4](#) for how to print).

• If the Install Tool finds only one printer, a wireless network configuration dialogue will pop up when you click on "One-click installation" under Wi-Fi. Enter the SSID and password for the network you desire, click on "OK", and the setup will start. The setup may take a while, depending on your PC configuration. Please wait.

The image shows a screenshot of a PANTUM wireless network configuration dialog box. The dialog has a title bar with the PANTUM logo and a close button. The main content area contains two steps:

1. Please click on "Printing wireless network information page" to get the network name and encryption method. Please skip this step if you already know the network name and encryption method.
2. Please enter wireless network user name and password.  
Network Name(SSID):(2.4 GHz Only.)  
  
Password:  
  
 Show password:

At the bottom right, there are two buttons: "Back" and "OK".

• If your software has searched more than one printers, the printer list interface will pop up. You need to configure the current printer which is connected via USB cable to wireless network and install driver. Please select "Configure the print via USB and install" on the printer list interface and check the USB printer option. Click the "Confirm" button, and the wireless network configuration interface will pop up. Input the wireless SSID and password that you need, then click "Confirm" button, and enter into installation process. The process may need some time, and the duration is related to your computer configuration, please wait patiently.

**PANTUM**

Please select the printer you would like to install

Configure and install Wi-Fi via USB

Printer Name	Port

Wireless network printer

Printer Name	IP Address	Host name
<input checked="" type="checkbox"/> XXX Series 0002	<a href="#">10.10.134.46</a>	XXX-A4B5D3
<input type="checkbox"/> XXX Series 0003	<a href="#">10.10.134.240</a>	XXX-77DFAF

Install the printer from the list with a hostname [?](#)

Tips: If your printer is not in the list, please check the printer network status and see if it is in the same network as the current PC

**PANTUM**

1. Please click on "Printing wireless network information page" to get the network name and encryption method. Please skip this step if you already know the network name and encryption method.

2. Please enter wireless network user name and password.

Network Name(SSID):(2.4 GHz Only.)

Test-AP2

Password:

••••••••

Show password:

**Note:**• When the printer IP address changes under printer driver installed with host ID , you can also directly print without re-installing the driver. If you need to install the printer driver with the host ID, please check the option "Install the printer in the list with host ID".

7. After the installation, click "Print &Test Page" button. If your printer prints the test page successfully, it means that you have installed the driver correctly.

### 3.1.1.1.2. Connect computer to printer via Wi-Fi direct and install the driver

Connect the computer to printer via a direct Wi-Fi connection. It is applicable to wireless network without infrastructure mode, but it still needs scenario of temporary use of printer via wireless network. You can directly connect the computer that has wireless function to the printer to realize printing function.

1. Turn the power of printer and computer on.
2. Connect computer to the Wi-Fi Direct network of the printer (please refer to [Section 5.2.2](#) for setup method).
3. Place the attached installation CD in the computer CD-ROM:

For Windows:

- Windows XP system: automatically run the installation procedure.
- Windows 7/Vista/Server 2008 system: Pop up "Autoplay" interface, click "Setup.exe" to run the installation procedure.
- Windows 8 system: When the "DVD RW driver" window pops up from the right top corner of computer desktop, click anywhere in the pop-up window, then click "Setup.exe" to run the installation procedure.
- Windows 10/11 system: When the "DVD RW driver" window pops up from the right top corner of computer desktop, click anywhere in the window, then click "Setup.exe" to run the installation procedure.



---

**Note:** • Some computers may be unable to auto play the CD because of system configuration. Please double click "Computer" icon, find "DVD RW driver", then double click "DVD RW driver" to run the installation procedure.

---

For macOS:

- Double-click on "Pantum XXX Series\_Mac\_Driver" - "Pantum Install Tool". (The XXX in Pantum XXX Series refers to product model.)
4. Read and agree to the terms contained in the End User License Agreement and the Privacy Policy, click the "Next" button in the lower right corner of the interface to enter the driver installation interface.
  5. For Windows, follow Step 6. For macOS, enter PC password before proceeding to Step 6.

6. The setup will start when you click on "One-click installation" under Wi-Fi. The setup may take a while, depending on your PC configuration. Please wait.

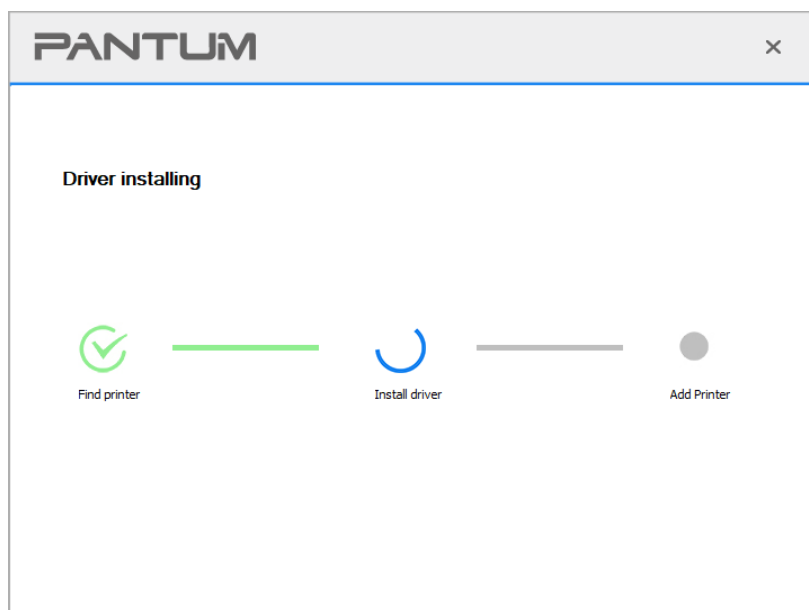
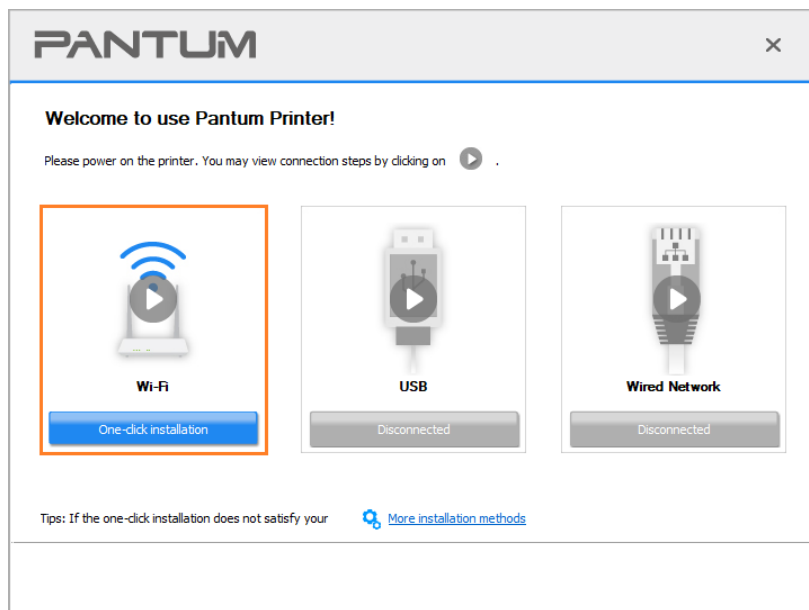

7. After the installation, click "Print & Test Page" button. If your printer prints the test page successfully, it means that you have installed the driver correctly.

### 3.1.1.1.2. The printer is already connected to wireless network

1. The printer is already connected to wireless network, you can print the "Network configuration page" to check.(See [Section 7.4](#) to for how to print).
2. Connect the computer to printer network.
3. Place the attached installation CD in the computer CD-ROM:

For Windows:

- Windows XP system: automatically run the installation procedure.
- Windows 7/Vista/Server 2008 system: Pop up "Autoplay" interface, click "Setup.exe" to run the installation procedure.
- Windows 8 system: When the " DVD RW driver" window pops up from the right top corner of computer desktop, click anywhere in the pop-up window, then click "Setup.exe" to run the installation procedure.
- Windows 10/11 system: When the "DVD RW driver" window pops up from the right top corner of computer desktop, click anywhere in the window, then click "Setup.exe" to run the installation procedure.

---

 **Note:** • Some computers may be unable to auto play the CD because of system configuration. Please double click "Computer" icon, find "DVD RW driver", then double click "DVD RW driver" to run the installation procedure.

---

For macOS:

- Double-click on "Pantum XXX Series\_Mac\_Driver" - "Pantum Install Tool". (The XXX in Pantum XXX Series refers to product model.)
4. Read and agree to the terms contained in the End User License Agreement and the Privacy Policy, click the "Next" button in the lower right corner of the interface to enter the driver installation interface.
  5. For Windows, follow Step 6. For macOS, enter PC password before proceeding to Step 6.
  6. Click on "One-click installation" button under Wi-Fi to install the driver.

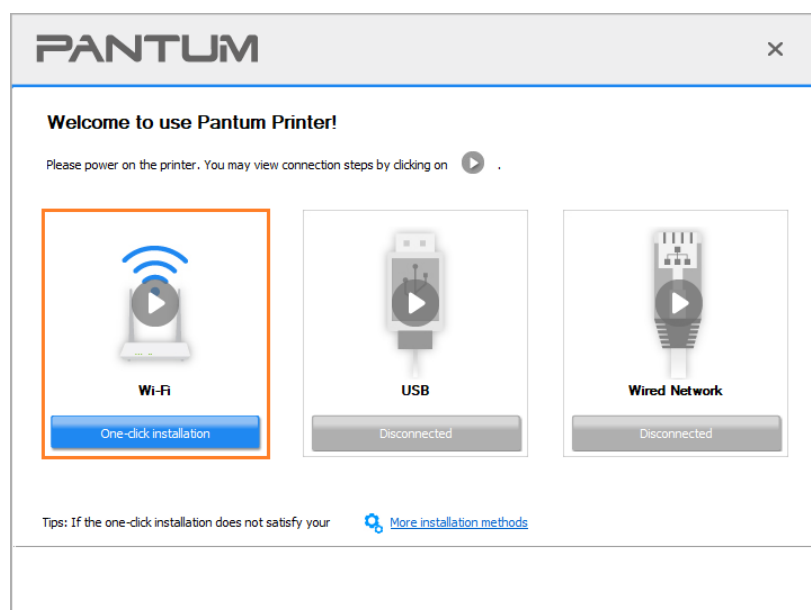



-  **Note:** • You can put your mouse cursor in the "One-click installation" button to check the popup information in order to confirm if the current printer is the one you need to install through IP address before you click the button.
- You can check the printer IP address through "Network configuration page" (Please see [Section 7.4](#) for how to print)

- If the Install Tool finds only one printer, the setup will start when you click on "One-click installation" under Wi-Fi. The setup may take a while, depending on your PC configuration. Please wait.

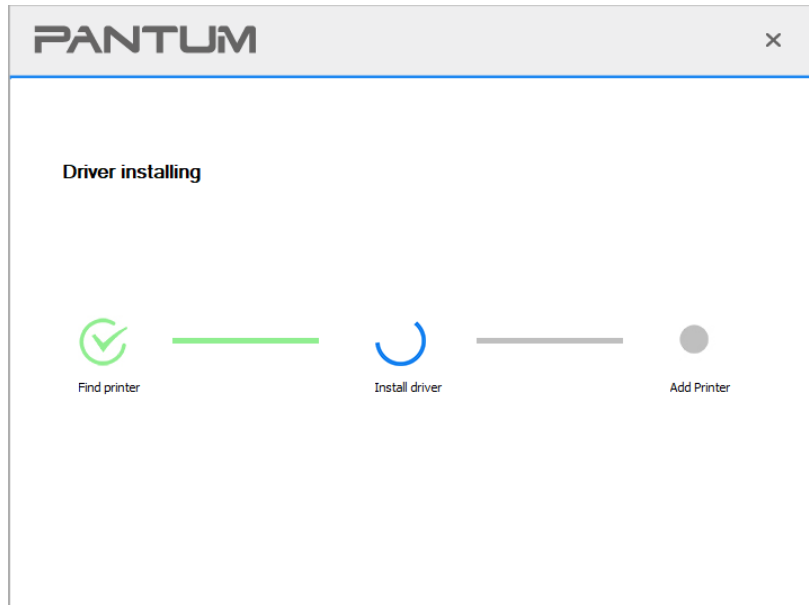

- If the Install Tool finds more than one printer, a printer list will pop up. Please select the printer you desire based on the IP Address of the wireless network for your printer or the Host Name.

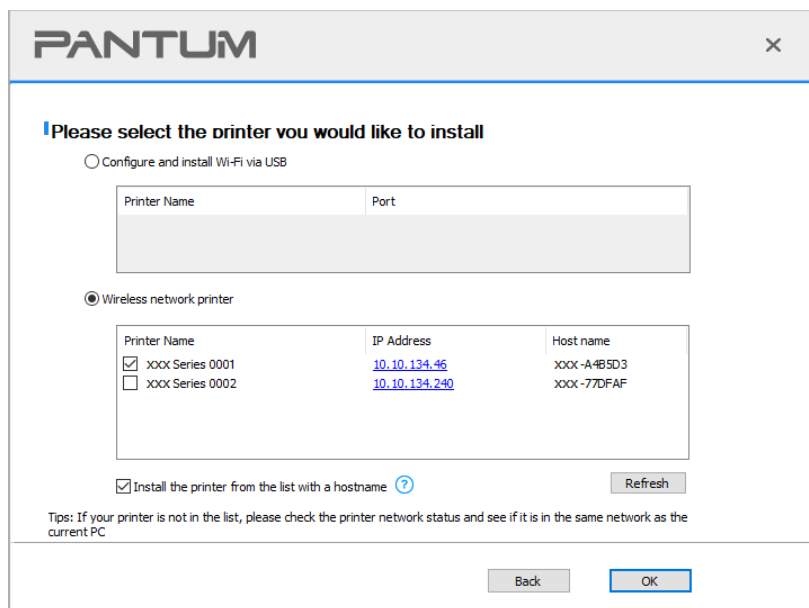



---

**Note:** • If the printer you need is not shown in the list, please click "Refresh" button to search again. If it is not found, please check if the printer and computer are in the same network. (Please see [Section 5.3](#) for how to check).

- When the printer IP address changes under printer driver installed with host ID, you can also directly print without re-installing the driver. If you need to install the printer driver with the host ID, please check the option "Install the printer in the list with host ID".

---

7. After the installation, click "Print & Test Page" button. If your printer prints the test page successfully, it means that you have installed the driver correctly.

### 3.1.1.2. Connect printer via USB cable

1. Connect the printer to computer via USB cable, power the printer and computer on.

2. Place the attached installation CD in the computer CD-ROM:

For Windows:

- Windows XP system: automatically run the installation procedure.
- Windows 7/Vista/Server 2008 system: Pop up "Autoplay" interface, click "Setup.exe" to run the installation procedure.
- Windows 8 system: When the "DVD RW driver" window pops up from the right top corner of computer desktop, click anywhere in the pop-up window, then click "Setup.exe" to run the installation procedure.
- Windows 10/11 system: When the "DVD RW driver" window pops up from the right top corner of computer desktop, click anywhere in the window, then click "Setup.exe" to run the installation procedure.



---

**Note:** • Some computers may be unable to auto play the CD because of system configuration. Please double click "Computer" icon, find "DVD RW driver", then double click "DVD RW driver" to run the installation procedure.

---

For macOS:

- Double-click on "Pantum XXX Series\_Mac\_Driver" - "Pantum Install Tool". (The XXX in Pantum XXX Series refers to product model.)
3. Read and agree to the terms contained in the End User License Agreement and the Privacy Policy, click the "Next" button in the lower right corner of the interface to enter the driver installation interface.
4. For Windows, follow Step 5. For macOS, enter PC password before proceeding to Step 5.

5. The setup will start when you click on "One-click installation" under USB. The setup may take a while, depending on your PC configuration. Please wait.

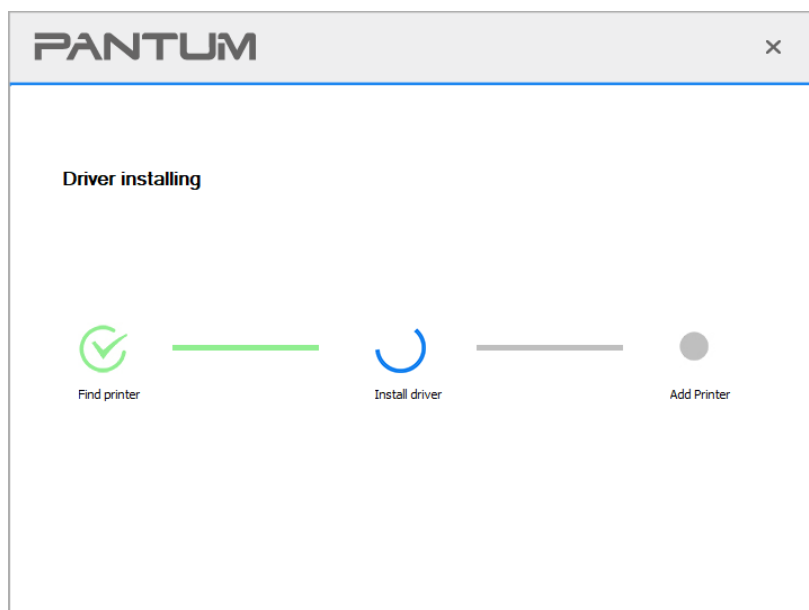
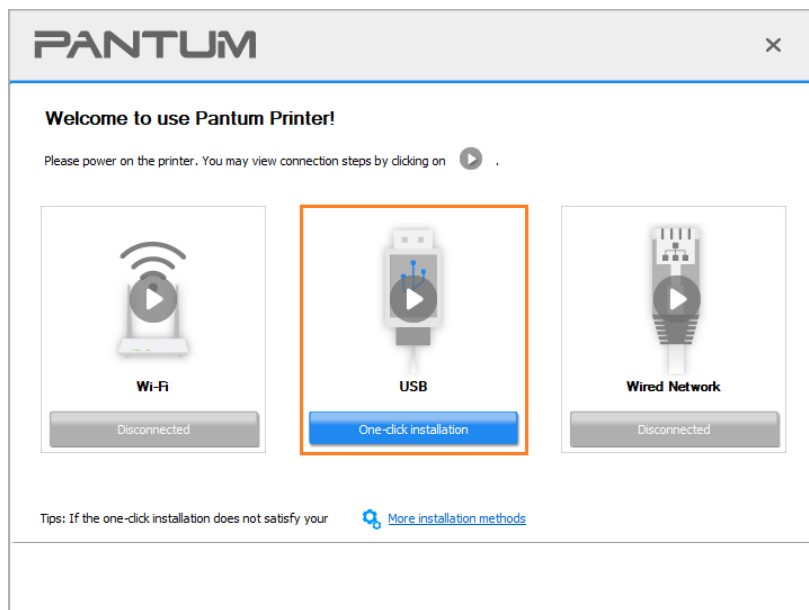

6. After the installation, click "Print & Test Page" button. If your printer prints the test page successfully, it means that you have installed the driver correctly.

### 3.1.1.3. Connect printer via wired network

1. Turn the power of printer and computer on.
2. Connect the computer to wired network.
3. Connect network cable to the network interface of printer, to make sure the printer is connected to computer network (please refer to [Section 4](#) for network setup).
4. Place the attached installation CD in the computer CD-ROM:

For Windows:

- Windows XP system: automatically run the installation procedure.

- Windows 7/Vista/Server 2008 system: Pop up "Autoplay" interface, click "Setup.exe" to run the installation procedure.
- Windows 8 system: When the "DVD RW driver" window pops up from the right top corner of computer desktop, click anywhere in the pop-up window, then click "Setup.exe" to run the installation procedure.
- Windows 10/11 system: When the "DVD RW driver" window pops up from the right top corner of computer desktop, click anywhere in the window, then click "Setup.exe" to run the installation procedure.

---

 **Note:** • Some computers may be unable to auto play the CD because of system configuration. Please double click "Computer" icon, find "DVD RW driver", then double click "DVD RW driver" to run the installation procedure.

---

For macOS:

- Double-click on "Pantum XXX Series\_Mac\_Driver" - "Pantum Install Tool". (The XXX in Pantum XXX Series refers to product model.)
5. Read and agree to the terms contained in the End User License Agreement and the Privacy Policy, click the "Next" button in the lower right corner of the interface to enter the driver installation interface.
  6. For Windows, follow Step 7. For macOS, enter PC password before proceeding to Step 7.
  7. Click on "One-click installation" button under Wired Network to install the driver.

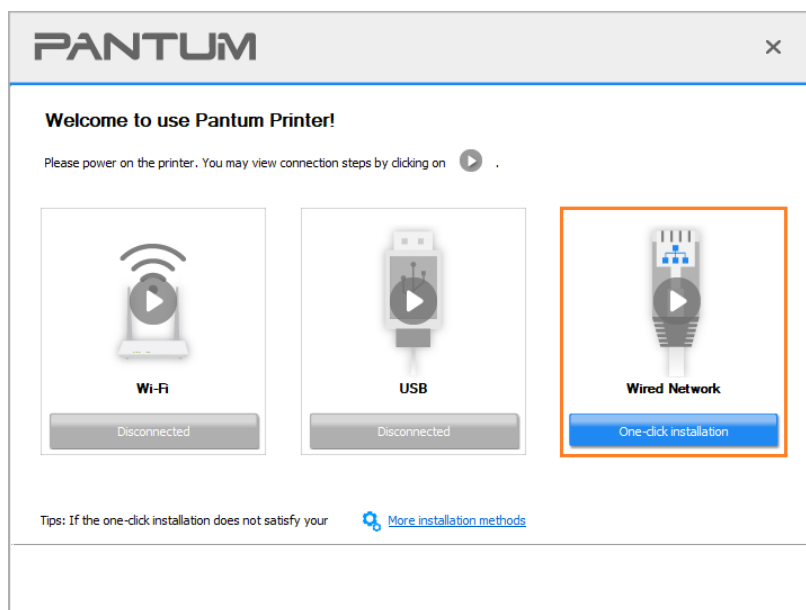



---

 **Note:** • You can put your mouse cursor in the "One-click installation" button to check the popup information in order to confirm if the current printer is the one you need to install through IP address before you click the button.

- You can check the printer IP address through "Network configuration page" (Please see [Section 7.4](#) for how to print)

---

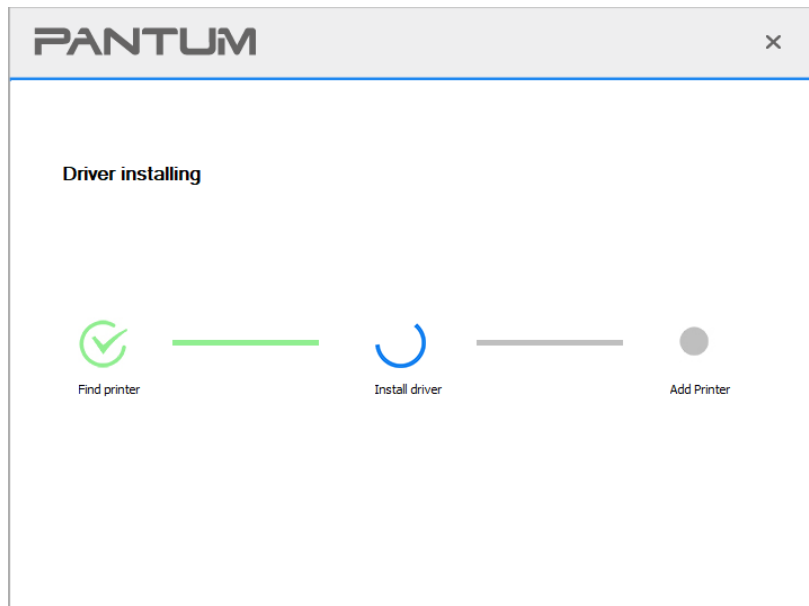
- If the Install Tool finds only one printer, the setup will start when you click on "One-click installation" under Wired Network. The setup may take a while, depending on your PC configuration. Please wait.



- If the Install Tool finds more than one printer, a printer list will pop up when you click on "One-click installation" under Wired Network. Please select the printer you desire based on the IP Address of the wired network for your printer or the Host Name.

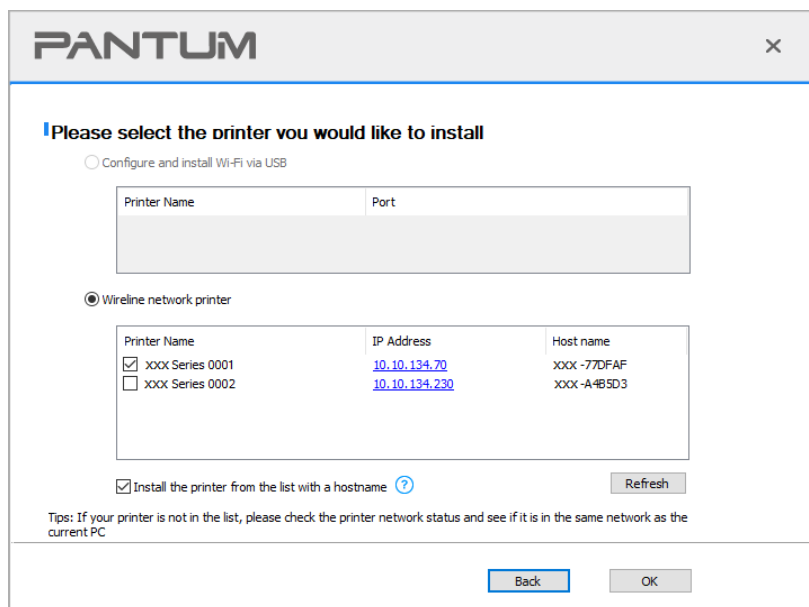

- 
-  **Note:**• If the printer you need is not shown in the list, please click "Refresh" button to search again. If it is not found, please check if the printer and computer are in the same network. (Please see [Section 5.3](#) for how to check).
- When the printer IP address changes under printer driver installed with host ID , you can also directly print without re-installing the driver. If you need to install the printer driver with the host ID, please check the option "Install the printer in the list with host ID".
-

8. After the installation, click "Print & Test Page" button. If your printer prints the test page successfully, it means that you have installed the driver correctly.

## 3.1.2. More setup methods

### 3.1.2.1. More setup methods for Windows

- Before installing the drive, you need to learn about printer model by printing printer information page out and check the product name (please refer to [Section 7.4](#) for printing methods).

#### 3.1.2.1.1. Installation via USB connection

1. Connect the printer to computer via USB cable, power the printer and computer on.
2. Place the attached installation CD in the computer CD-ROM:
  - Windows XP system: automatically run the installation procedure.
  - Windows 7/Vista/Server 2008 system: Pop up "Autoplay" interface, click "Setup.exe" to run the installation procedure.
  - Windows 8 system: When the "DVD RW driver" window pops up from the right top corner of computer desktop, click anywhere in the pop-up window, then click "Setup.exe" to run the installation procedure.
  - Windows 10/11 system: When the "DVD RW driver" window pops up from the right top corner of computer desktop, click anywhere in the window, then click "Setup.exe" to run the installation procedure.



**Note:** • Some computers may be unable to auto play the CD because of system configuration. Please double click "Computer" icon, find "DVD RW driver", then double click "DVD RW driver" to run the installation procedure.

3. Read and agree to the terms contained in the End User License Agreement and the Privacy Policy, click the "Next" button in the lower right corner of the interface to enter the driver installation interface.
4. Click on "More setup methods" at the bottom of the setup interface for access.
5. Please select installation language and printer model.
6. Select "Connect via USB" and click on "Install".

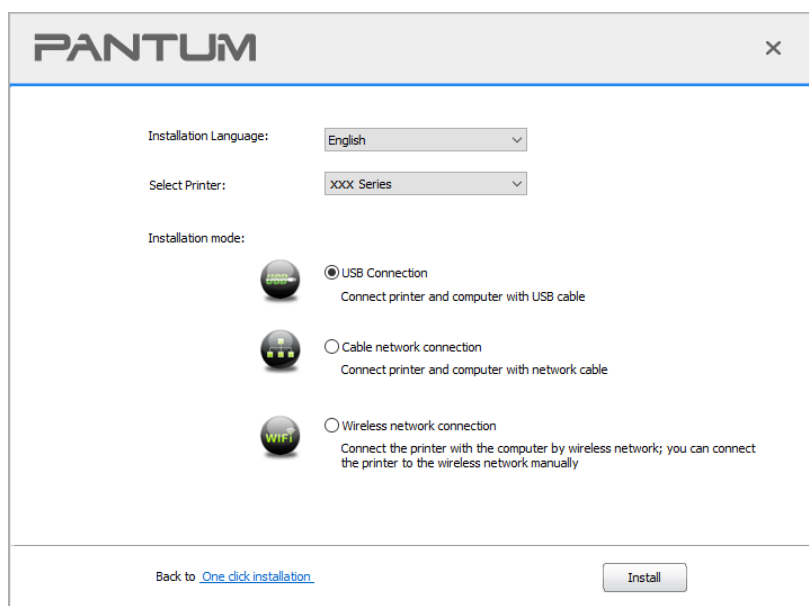

7. The software installs the driver automatically and the installation process may need some time. The duration is related to your computer configuration, please wait patiently.
8. After the installation, click "Print & Test Page" button. If your printer prints the test page successfully, it means that you have installed the driver correctly.

### 3.1.2.1.2. Installation via wired network connection (applicable to wired network models)

1. Turn the power of printer and computer on.
2. Connect the computer to wired network.
3. Connect network cable to the network interface of printer, to make sure the printer is connected to computer network (please refer to [Section 4](#) for network setup).
4. Place the attached installation CD in the computer CD-ROM:
  - Windows XP system: automatically run the installation procedure.
  - Windows 7/Vista/Server 2008 system: Pop up "Autoplay" interface, click "Setup.exe" to run the installation procedure.
  - Windows 8 system: When the "DVD RW driver" window pops up from the right top corner of computer desktop, click anywhere in the pop-up window, then click "Setup.exe" to run the installation procedure.
  - Windows 10/11 system: When the "DVD RW driver" window pops up from the right top corner of computer desktop, click anywhere in the window, then click "Setup.exe" to run the installation procedure.



**Note:** • Some computers may be unable to auto play the CD because of system configuration. Please double click "Computer" icon, find "DVD RW driver", then double click "DVD RW driver" to run the installation procedure.

5. Read and agree to the terms contained in the End User License Agreement and the Privacy Policy, click the "Next" button in the lower right corner of the interface to enter the driver installation interface.
6. Click on "More setup methods" at the bottom of the setup interface for access.
7. Please select installation language and printer model.
8. Select "Wireline network connection" and click on "Install".

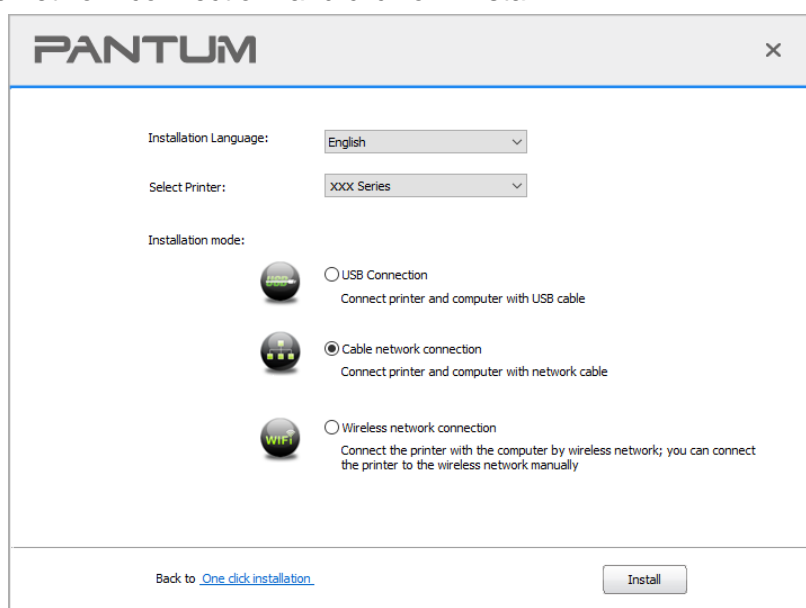

9. The installation software will search the printer automatically and the searching process may need some time.

10. After finishing searching, select the printer that needs to be connected and click "Next".

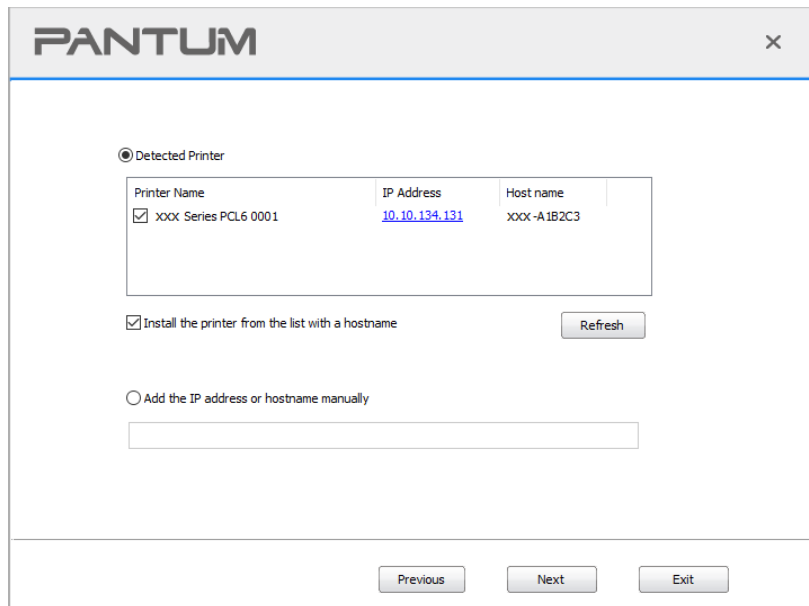

 **Note:** If the printer you need to connect is not in the list of printers searched, please click "Refresh" to search again.

- When the printer IP address changes under printer driver installed with host ID, you can also directly print without re-installing the driver. If you need to install the printer driver with the host ID, please check the option "Install the printer in the list with host ID".
- If IP address or host name is added manually, you need to know the IP address of the printer connected or host name. If they are not made clear, please print the "NetConf Pg" and view "IP Address" and "Host name" (Please refer to [Section 7.4](#)).

11. The software installs the driver automatically and the installation process may need some time. The duration is related to your computer configuration, please wait patiently.

12. After the installation, click "Print & Test Page" button. If your printer prints the test page successfully, it means that you have installed the driver correctly.

### 3.1.2.1.3. Installation by wireless network connection mode (applicable to Wi-Fi models)

Wireless network connection type is divided into basic structure mode and Wi-Fi Direct mode (please refer to [Section 5](#) for details).

#### 3.1.2.1.3.1. Installation in basic structure mode

1. Connect computer to access point (wireless router).
2. Connect the printer to computer via USB cable, then power the printer on.
3. Place the attached installation CD in the computer CD-ROM:
  - Windows XP system: automatically run the installation procedure.
  - Windows 7/Vista/Server 2008 system: Pop up "Autoplay" interface, click "Setup.exe" to run the installation procedure.



- Windows 8 system: When the "DVD RW driver" window pops up from the right top corner of computer desktop, click anywhere in the pop-up window, then click "Setup.exe" to run the installation procedure.
- Windows 10/11 system: When the "DVD RW driver" window pops up from the right top corner of computer desktop, click anywhere in the window, then click "Setup.exe" to run the installation procedure.



**Note:**• Some computers may be unable to auto play the CD because of system configuration. Please double click "Computer" icon, find "DVD RW driver", then double click "DVD RW driver" to run the installation procedure.

4. Read and agree to the terms contained in the End User License Agreement and the Privacy Policy, click the "Next" button in the lower right corner of the interface to enter the driver installation interface.
5. Click on "More setup methods" at the bottom of the setup interface for access.
6. Please select installation language and printer model.
7. Select "Wireless network connection" and click on "Install".

The screenshot shows the PANTUM driver installation window. At the top, the PANTUM logo is on the left and a close button (X) is on the right. Below the logo, there are three sections: 'Installation Language:' with a dropdown menu set to 'English'; 'Select Printer:' with a dropdown menu set to 'XXX Series'; and 'Installation mode:' with three radio button options. The first option is 'USB Connection' with a subtext 'Connect printer and computer with USB cable'. The second is 'Cable network connection' with a subtext 'Connect printer and computer with network cable'. The third is 'Wireless network connection' with a subtext 'Connect the printer with the computer by wireless network; you can connect the printer to the wireless network manually'. The 'Wireless network connection' option is selected. At the bottom left, there is a link 'Back to [One click installation](#)'. At the bottom right, there is an 'Install' button.

8. Select “Yes, I want to configure the printer's wireless network” on the wireless setup window popped out, and operate according to the prompts to set up the printer to wireless network (please refer to [Section 5.1.1](#) for setup method).

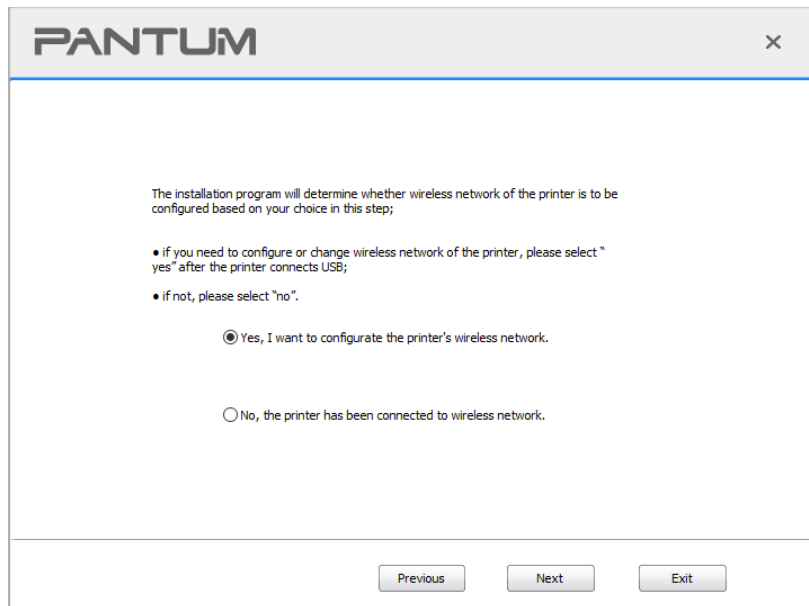

9. The installation software will search the printer automatically after wireless network is configured successfully. The search process may need some time.

10. Select the printer needs to be connected and click “Next”.

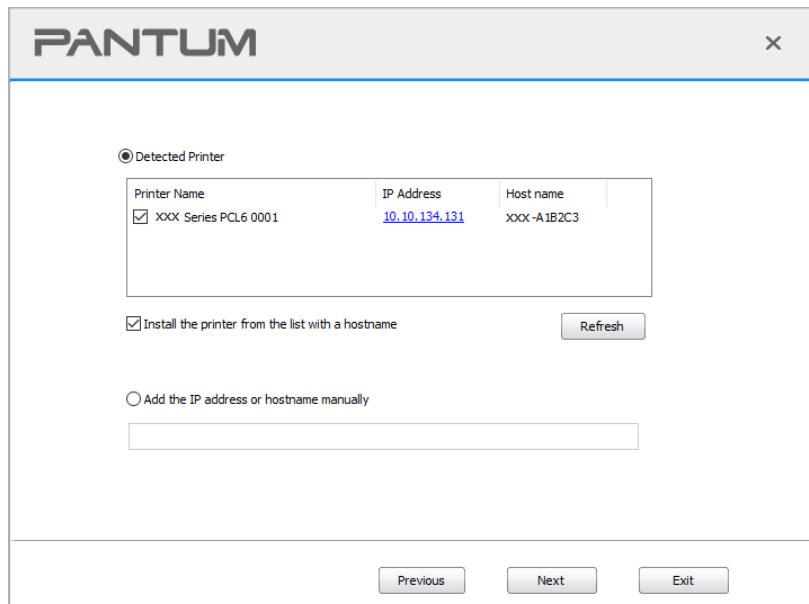



---

**Note:** • If the printer you need to connect is not in the list of printers searched, please click “Refresh” to search again.

- When the printer IP address changes under printer driver installed with host ID , you can also directly print without re-installing the driver. If you need to install the printer driver with the host ID, please check the option "Install the printer in the list with host ID".
  - If IP address or host name is added manually, you need to know the IP address of the printer connected or host name. If they are not made clear, please print the “NetConf Pg” and view “IP Address” and “Host name” (Please refer to [Section 7.4](#)).
- 

11. The software installs the driver automatically and the installation process may need some time. The duration is related to your computer configuration, please wait patiently.

12. After the installation, click "Print &Test Page" button. If your printer prints the test page successfully, it means that you have installed the driver correctly.

### **3.1.2.1.3.2. Installation in Wi-Fi Direct mode**

1. Turn the power of printer and computer on.

2. Connect computer to the Wi-Fi Direct network of the printer (please refer to [Section 5.2.2](#) for setup method).

3. Place the attached installation CD in the computer CD-ROM:

- Windows XP system: automatically run the installation procedure.
- Windows 7/Vista/Server 2008 system: Pop up "Autoplay" interface, click “Setup.exe” to run the installation procedure.
- Windows 8 system: When the " DVD RW driver" window pops up from the right top corner of computer desktop, click anywhere in the pop-up window, then click "Setup.exe" to run the installation procedure.
- Windows 10/11 system: When the "DVD RW driver" window pops up from the right top corner of computer desktop, click anywhere in the window, then click "Setup.exe" to run the installation procedure.



---

**Note:** • Some computers may be unable to auto play the CD because of system configuration. Please double click "Computer" icon, find "DVD RW driver", then double click "DVD RW driver" to run the installation procedure.

---

4. Read and agree to the terms contained in the End User License Agreement and the Privacy Policy, click the “Next” button in the lower right corner of the interface to enter the driver installation interface.

5. Click on “More setup methods” at the bottom of the setup interface for access.

6. Please select installation language and printer model.

7. Select "Wireless network connection" and click on "Install".

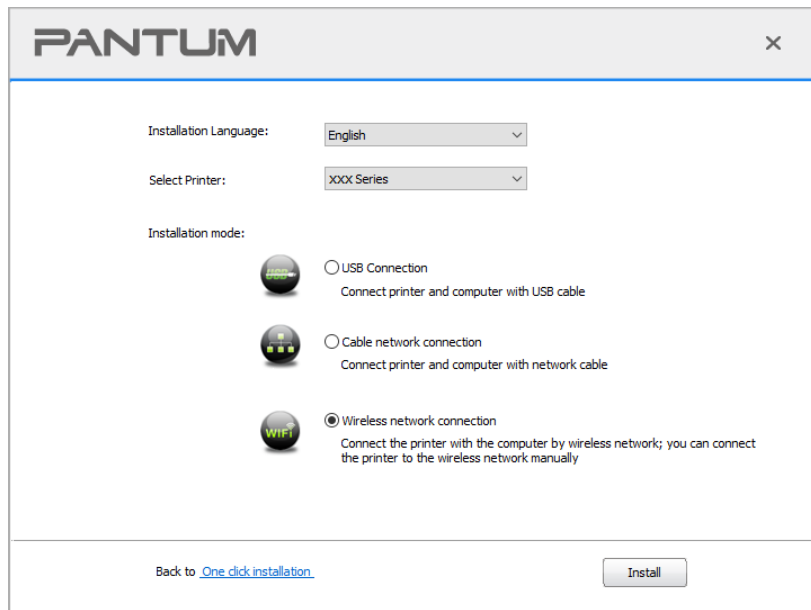

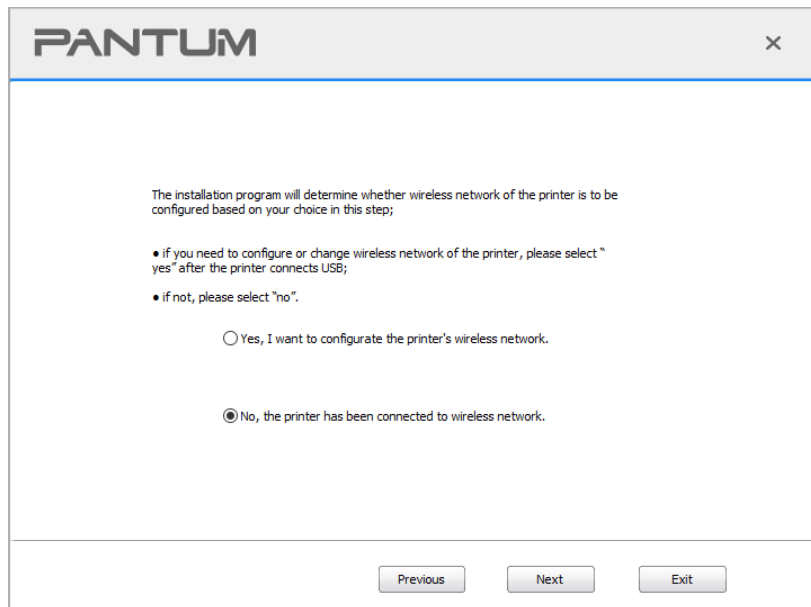

8. Select "No, the printer has been connected to wireless network" on the wireless setup window popping out, and then click "Next".

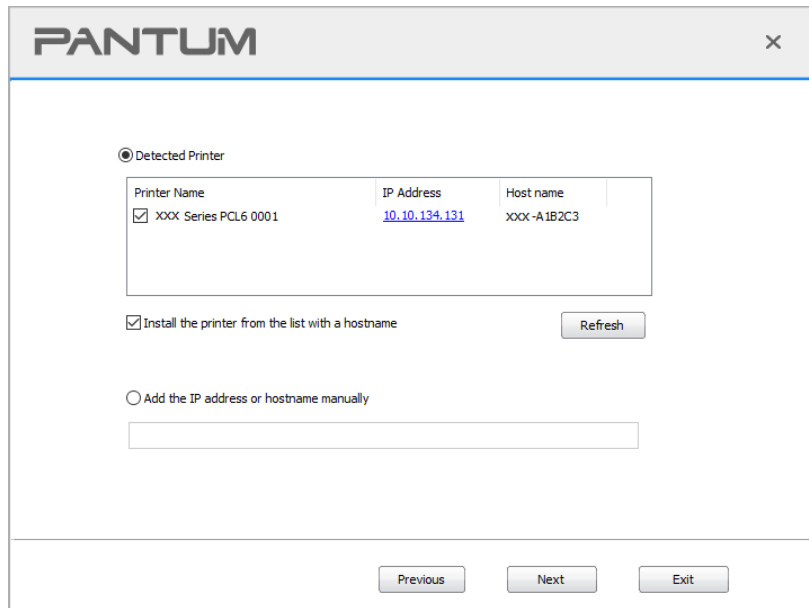

9. The installation software will search the printer automatically and the searching process may need some time.

10. Select the printer needs to be connected and click “Next”.



 **Note:** • If the printer you need to connect is not in the list of printers searched, please click “Refresh” to search again.

- When the printer IP address changes under printer driver installed with host ID , you can also directly print without re-installing the driver. If you need to install the printer driver with the host ID, please check the option "Install the printer in the list with host ID".
- If IP address or host name is added manually, you need to know the IP address of the printer connected or host name. If they are not made clear, please print the “NetConf Pg” and view “IP Address” and “Host name” (Please refer to [Section 7.4](#)).

11. The software installs the driver automatically and the installation process may need some time. The duration is related to your computer configuration, please wait patiently.

12. After the installation, click "Print & Test Page" button. If your printer prints the test page successfully, it means that you have installed the driver correctly.

### 3.1.2.2. More setup methods for macOS

#### 3.1.2.2.1. Install via USB cable

macOS 10.14 is taken as the example in the following operation. The information on your computer screen may differ because of multiple operating systems.

1. Turn the power of printer and computer on.

2. Insert the setup CD supplied in the CD-ROM of the PC, and double-click on "Pantum XXX Series\_Mac\_Driver" – "Pantum Install Tool". (The XXX in Pantum XXX Series refers to product model.)

3. Read and agree to the terms contained in the End User License Agreement and the Privacy Policy, click the “Next” button in the lower right corner of the interface to enter the driver installation interface.

4. Enter the password of the PC, and click on “OK”.

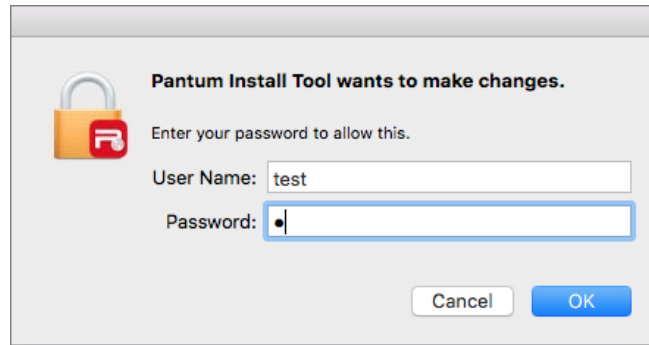

5. Click on “More setup methods” at the bottom of the setup interface for access.

6. Select a USB printer from the search results.

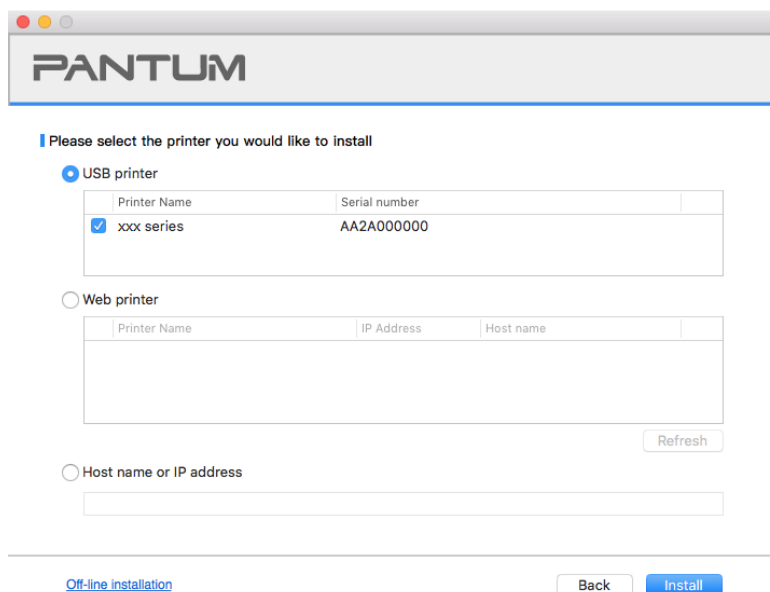

7. Click on “Install” on the lower right.

8. The software installs the driver automatically and the installation process may need some time. The duration is related to your computer configuration, please wait patiently.

9. After the installation, click "Print & Test Page" button. If your printer prints the test page successfully, it means that you have installed the driver correctly.

### 3.1.2.2.2. Install as a network printer

1. Turn the power of printer and computer on.

2. Connect the PC to the network.

3. Make sure the printer is connected to the same network as the PC (See [Section 4](#) or [5](#) to learn how to configure the network).

4. Insert the setup CD supplied in the CD-ROM of the PC, and double-click on "Pantum XXX Series\_Mac\_Driver" – "Pantum Install Tool". (The XXX in Pantum XXX Series refers to product model.)

5. Read and agree to the terms contained in the End User License Agreement and the Privacy Policy, click the “Next” button in the lower right corner of the interface to enter the driver installation interface.

6. Enter the password of the PC, and click on “OK”.

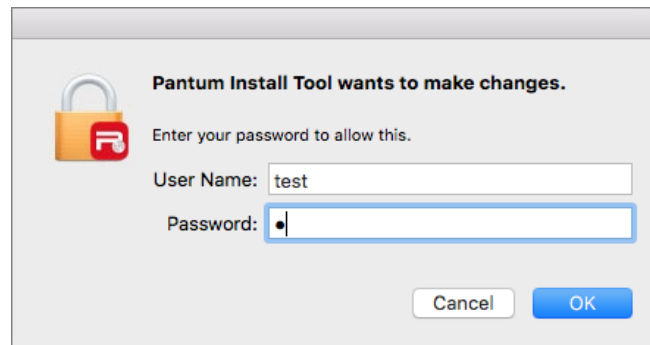

7. Click on “More setup methods” at the bottom of the setup interface for access.

8. Select a network printer from the search results.

9. Click on “Install” on the lower right.

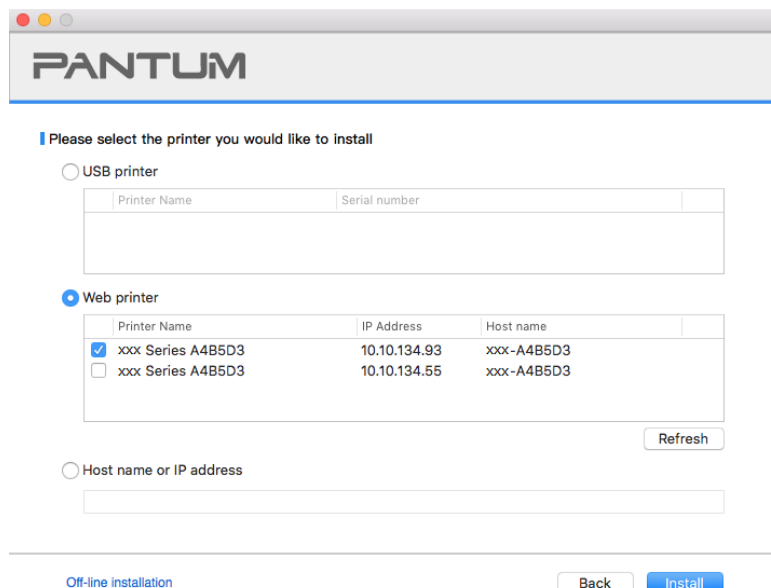

 **Note:** • If the printer you need to connect is not in the list of printers searched, please click “Refresh” to search again.

- When the printer IP address changes under printer driver installed with host ID , you can also directly print without re-installing the driver. If you need to install the printer driver with the host ID, please check the option "Install the printer in the list with host ID".
- If IP address or host name is added manually, you need to know the IP address of the printer connected or host name. If they are not made clear, please print the “NetConf Pg” and view “IP Address” and “Host name” (Please refer to [Section 7.4](#)).

10. The software installs the driver automatically and the installation process may need some time. The duration is related to your computer configuration, please wait patiently.

11. After the installation, click "Print & Test Page" button. If your printer prints the test page successfully, it means that you have installed the driver correctly.

### 3.1.2.2.3. Install via Host Name or IP Address

1. Turn the power of printer and computer on.
2. Connect the PC to the network.
3. Make sure the printer is connected to the same network as the PC (See [Section 4](#) or [5](#) to learn how to configure the network).
4. Insert the setup CD supplied in the CD-ROM of the PC, and double-click on "Pantum XXX Series\_Mac\_Driver" – "Pantum Install Tool". (The XXX in Pantum XXX Series refers to product model.)
5. Read and agree to the terms contained in the End User License Agreement and the Privacy Policy, click the "Next" button in the lower right corner of the interface to enter the driver installation interface.
6. Enter the password of the PC, and click on "OK".

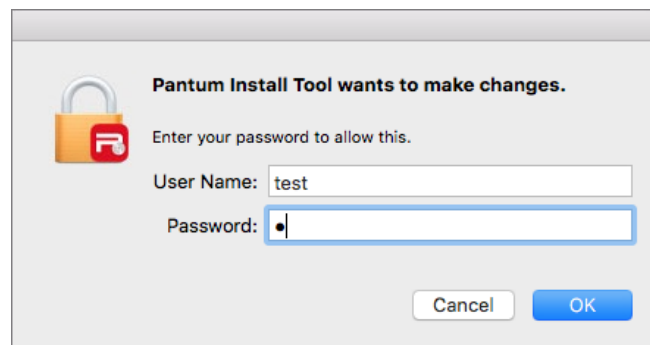

7. Click on "More setup methods" at the bottom of the setup interface for access.
8. Select Host Name or IP Address, and enter the Host Name or IP address of the printer you wish to add.
9. Click on "Install" on the lower right.

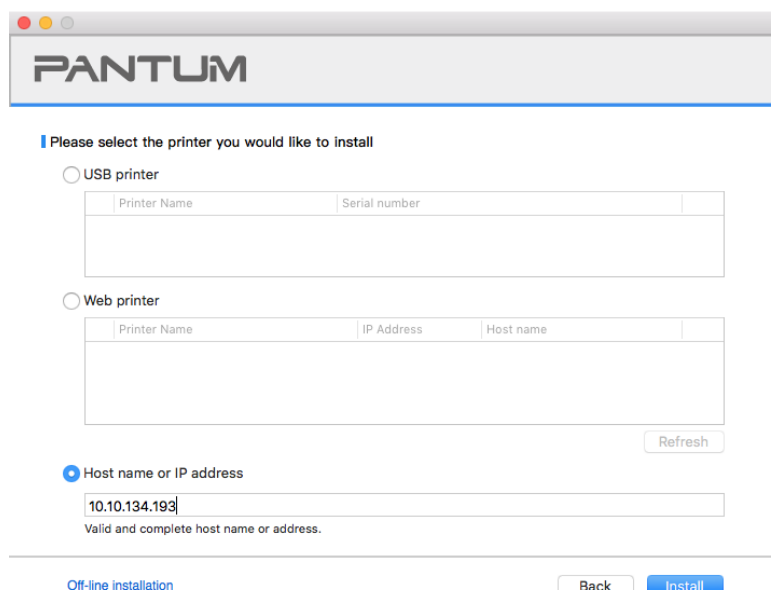





**Note:**• If the printer you need to connect is not in the list of printers searched, please click “Refresh” to search again.

- When the printer IP address changes under printer driver installed with host ID , you can also directly print without re-installing the driver. If you need to install the printer driver with the host ID, please check the option "Install the printer in the list with host ID".
- If IP address or host name is added manually, you need to know the IP address of the printer connected or host name. If they are not made clear, please print the “NetConf Pg” and view “IP Address” and “Host name” (Please refer to [Section 7.4](#)).

10. The software installs the driver automatically and the installation process may need some time. The duration is related to your computer configuration, please wait patiently.

11. After the installation, click "Print &Test Page" button. If your printer prints the test page successfully, it means that you have installed the driver correctly.

#### 3.1.2.2.4. Off-line Install

1. Turn the power of printer and computer on.
2. Insert the setup CD supplied in the CD-ROM of the PC, and double-click on "Pantum XXX Series\_Mac\_Driver" – "Pantum Install Tool". (The XXX in Pantum XXX Series refers to product model.)
3. Read and agree to the terms contained in the End User License Agreement and the Privacy Policy, click the “Next” button in the lower right corner of the interface to enter the driver installation interface.
4. Enter the password of the PC, and click on “OK”.

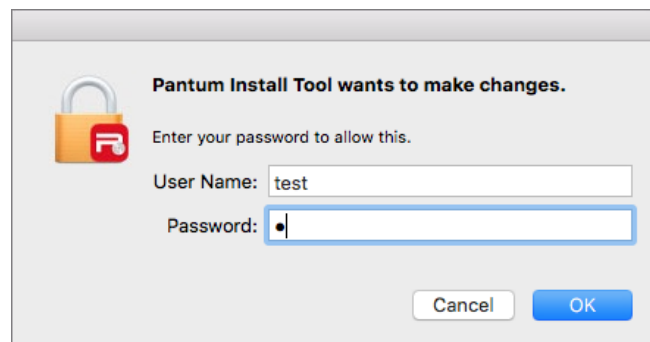

5. Click on “More setup methods” at the bottom of the setup interface for access.

6. Click on "Off-line installation" on the lower left.

Please select the printer you would like to install

USB printer

Printer Name	Serial number
--------------	---------------

Web printer

Printer Name	IP Address	Host name
--------------	------------	-----------

Refresh

Host name or IP address

Off-line installation Back Install

7. The software installs the driver automatically and the installation process may need some time.

The duration is related to your computer configuration, please wait patiently.

8. Install complete. Please finish printer adding as guided or refer to [Section 3.1.2.2.4.1](#).

### 3.1.2.2.4.1. Add printer to macOS system

#### I. Add up the printer via USB

1. Connect the printer to computer with USB cable and then turn power on.
2. Enter the "System Preferences" – "Printers & Scanners" of computer.
3. Click **+** button to select "Add Printer or Scanner".
4. Select printer and then select the corresponding printer mode from the "Use" menu popping out.
5. Click "Add".

#### II. Add up the printer via wireline connection (applicable to wired network models)

1. Turn the power of printer and computer on.
2. Connect the computer to wired network.
3. Connect the network cable to the network interface of printer, and make sure the printer is connected to the computer network (Please refer to [Section 4](#) for network setup).
4. Enter the "System Preferences" – "Printers & Scanners" of computer.
5. Click **+** button to select "Add Printer or Scanner".
6. Select printer and then select the corresponding printer mode from the "Use" menu popping out.
7. Click "Add".

#### III. Add up the printer via wireless connection (applicable to Wi-Fi models)

1. Turn the power of printer and computer on.
2. Make sure the wireless network connection between computer and printer is set up.

---

 **Note:** • In case of basic structure mode, connect wireless network printer to the access point (wireless router). Please refer to [Section 5.1](#) for connection method.  
• In case of Wi-Fi Direct mode, connect wireless client to wireless network printer directly. Please refer to [Section 5.2](#) for connection methods.

---

3. Enter the “System Preferences” – “Printers & Scanners” of computer.
4. Click  button to select “Add Printer or Scanner”.
5. Select printer and then select the corresponding printer mode from the “Use” menu popping out.
6. Click “Add”.

#### **IV. Add AirPrint printer**

1. Turn the power of printer and computer on.
2. Make sure the connection between printer and computer is set up (USB connection or network connection).
3. Enter the “System Preferences” – “Printers & Scanners” of computer.
4. Click  button to select “Add Printer or Scanner”.
5. Select printer and select “Secure AirPrint” (data encryption) or “AirPrint” (no encryption) in the “Use” option box.
6. Click “Add”.



- 
- Note:**
- When the printer is connected to computer with USB cable, the system will recognize and add AirPrint automatically.
  - If AirPrint printer of network connection is added, then the connecting USB cable should be disconnected first before adding the printer.
  - AirPrint printer is named after the ending of "AirPrint".
- 

## **3.2. Uninstall Driver**

### **3.2.1. Method to uninstall driver under Windows**

Windows 7 is taken as the example in the following operation. The information on your computer screen may differ because of multiple operating systems.

1. Click the Start menu of computer and then click All programs.
2. Click Pantum, and then Click Pantum XXX Series.  
Pantum XXX Series where XXX represents product model.
3. Click uninstall to delete the driver according to instructions on uninstall window.
4. Restart computer after finishing unloading.

### **3.2.2. Method to uninstall driver under macOS**

macOS10.14 is taken as the example in the following operation. The information on your computer screen may differ because of multiple operating systems.

1. Click "Go" - "Applications" - "Pantum" - "Utilities" - "Pantum Un-install Tool".
2. Delete the driver as instructed in the pop-up Uninstall window.
3. Uninstall complete.

## 4. Wired Network Settings (For printer models that support wired network printing)

Printers that support wired network printing can be connected to the network, thereby the printer will work under the control through a wired network.

 **Note:** • Due to printer upgrades, some functions may be different, depending on the model you purchased. If you have any questions, please contact Pantum Customer Service.

### 4.1. Install the Printer to Network

Please refer to [Chapter 3.1](#) to see the installation steps of NET Model.

### 4.2. Control the Network Printer

User can control the network settings through the built-in WEB Server in the printer.

#### 4.2.1. View or Change Network Settings

1. View the IP address of the printer on its control panel according to steps in [Section 7.3](#).
2. Type the IP address into the Web browser's address bar to access the embedded Web server of the printer.
3. Complete the settings of the Networking Protocol, wireless network, Wi-Fi hotspot, address list, e-mail and other relative configuration information in the "Setting".

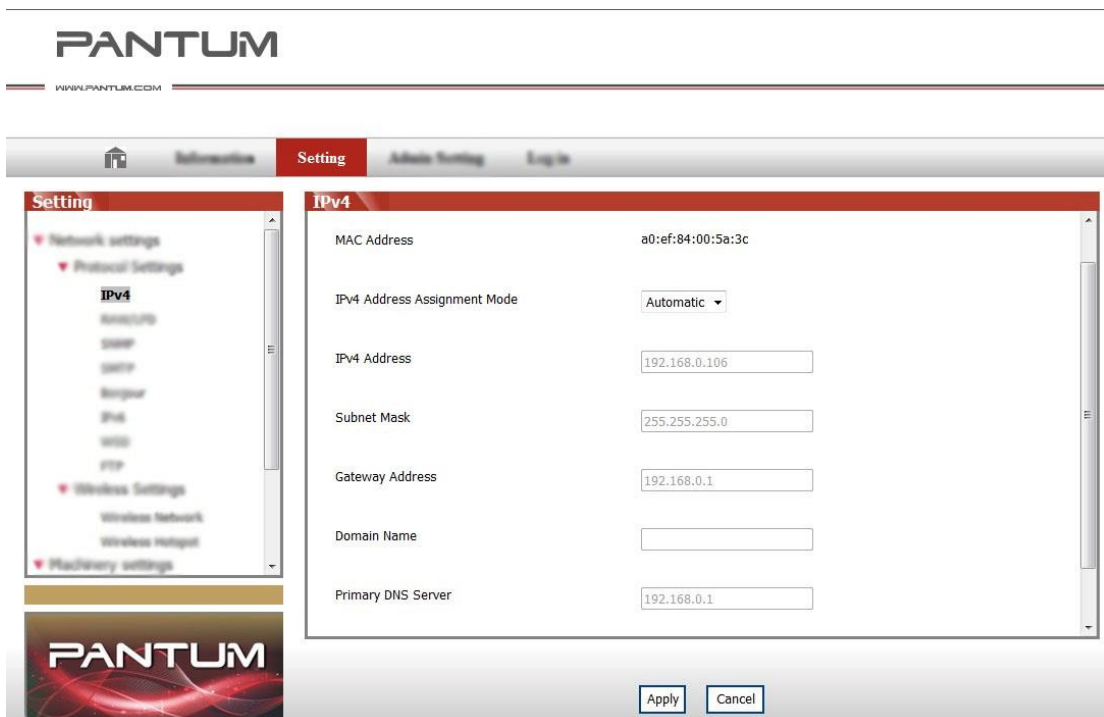

The screenshot displays the Pantum printer's web interface. At the top, the Pantum logo and website URL (WWW.PANTUM.COM) are visible. Below the logo is a navigation bar with tabs for Information, Setting (selected), Admin Setting, and Login. The main content area is divided into two panels. The left panel, titled 'Setting', shows a tree view of configuration options: Network settings, Protocol settings, IPv4 (selected), Wireless Settings, and Machinery settings. The right panel, titled 'IPv4', contains the following settings:

MAC Address	a0:ef:84:00:5a:3c
IPv4 Address Assignment Mode	Automatic
IPv4 Address	192.168.0.106
Subnet Mask	255.255.255.0
Gateway Address	192.168.0.1
Domain Name	
Primary DNS Server	192.168.0.1

At the bottom of the IPv4 panel, there are 'Apply' and 'Cancel' buttons.

## 4.2.2. Set or Change Web Server Login Password

You can manage the printer through User Management.

Steps:

1. After opening the built-in WEB server, log in (default user name is admin, default password is 000000).
2. Click "User Management" to execute proper actions.

## 4.2.3. SNMP protocol setup

You can set the SNMP protocol through the SNMP interface to improve the network information security of the printer.

1. Turn on printer power to connect printer to network.
2. Log in the embedded Web server (please refer to [Chapter 4.2.2](#) for login method).
3. Click "Setup" – "Network Setup" – "SNMP".
4. Check relevant SNMP protocols as needed, click "Apply".



**Note:** The SNMP protocol can improve the efficiency of network management, receive notification messages and warning event reports from network nodes, and help you discover and solve network issues in a timely manner.

- Enable SNMP v1/v2 protocol:

- ① Your printer may be at risk of unsafe network environment, please use it with caution!

- Disable SNMP v1/v2 protocol:

- ① The printer may not work properly because the driver installation fails. Please download the latest driver for this printer on the official website.

- ② Third-party software may not be able to obtain the SNMP status information of the printer, please use it with caution!

---

## 5. Wireless network setup (applicable to Wi-Fi models)

Depending on model, the printer with Wi-Fi printing function supports the two types of wireless network connection of both infrastructure connection and Wi-Fi hotspot connection, while there is usually only one connection between computer and printer at a time. If you have problems during wireless network setup, please refer to [Chapter 5.3](#) Wireless Network Setup Frequently Asked Questions.

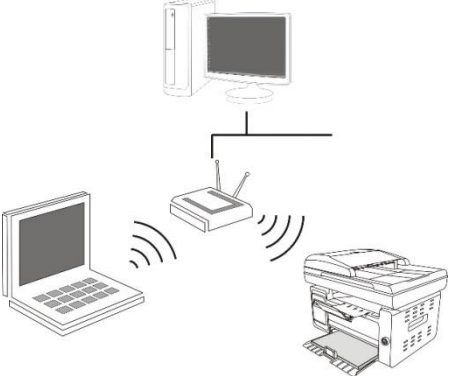
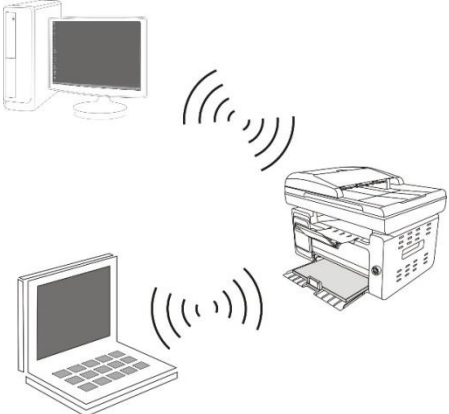
	<p>Basic structure mode: connecting to a wireless device via router</p> <ol style="list-style-type: none"><li>1. Access point (wireless router)</li><li>2. Wireless network printer</li><li>3. Computer connecting to access point via wireless network</li><li>4. Computer connecting to access point via network cable</li></ol>
	<p>Wi-Fi Hotspot The wireless computer is directly connected with the wireless device.</p>

### 5.1. Basic structure mode

You can connect a computer to your printer via access point (wireless router) as the medium. Access point (wireless router) connection is divided into wireless network setup and Wi-Fi Protected Setup (WPS).

---

 **Note:** • The machine with the fax feature supports automatic search of wireless network through the printer's control panel to select the wireless network you desire and then input its password for connection.

---

**Important:** Before wireless network installation, you must learn about the service set identifier (SSID) and password of your access point in order to use them during wireless network setup. If they cannot be determined, please consult your network administrator or access point (wireless router) manufacturer.

## 5.1.1. Wireless network setup tools

If your computer has been installed with a driver and had been connected to wireless network, but the wireless network was changed, you can set it again with wireless network setup tools.

### 5.1.1.1. Preliminary preparations

1. Access point (wireless router).
2. A computer that has been connected to network.
3. A printer that has wireless network function.

### 5.1.1.2. Setup methods of wireless network setup tools

1. Take the wireless network setup tool in computer.

1) **Windows system:** Click the "Start menu" – "All programs" - "Pantum" – Product name – "Wireless network setup tool".

2) **macOS system:** click "Go" - "Applications" - "Pantum" - "Utilities" - "Wireless Network Configuration Tool" on the computer Finder menu bar.

2. Use USB cable to connect and configure. Select "Yes, I have an USB cable that can be used for installation" in the following interface. Click "Next".

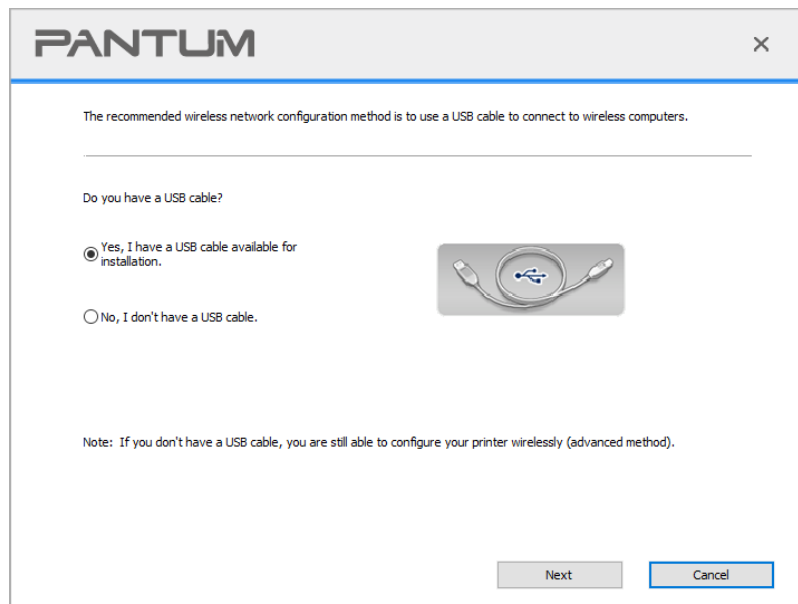

2.1 The computer has been connected to wireless network.

1) The currently wireless network currently connected to computer is selected as wireless network configuration tool by default. Complete configuration according to interface prompt.

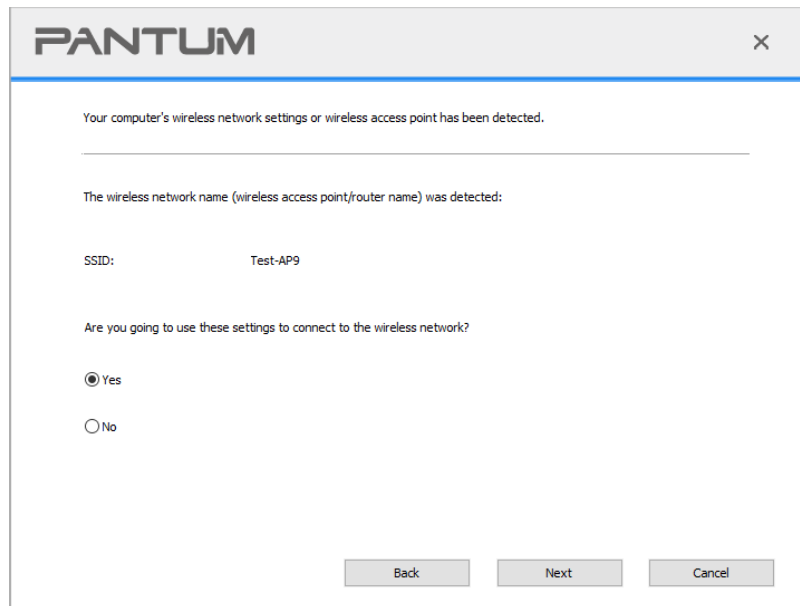

The screenshot shows a PANTUM window titled "PANTUM" with a close button (X) in the top right corner. The main content area contains the following text and elements:

- Message: "Your computer's wireless network settings or wireless access point has been detected."
- Separator line
- Text: "The wireless network name (wireless access point/router name) was detected:"
- Text: "SSID: Test-AP9"
- Text: "Are you going to use these settings to connect to the wireless network?"
- Radio buttons:  Yes and  No
- Buttons: "Back", "Next", and "Cancel" at the bottom.

 **Note:** • The SSID you selected should be consistent with the SSID of access point (wireless router) connected to your computer.

2) Please tick "No" to configure other wireless network needed to connect to. Complete configuration according to interface prompt.

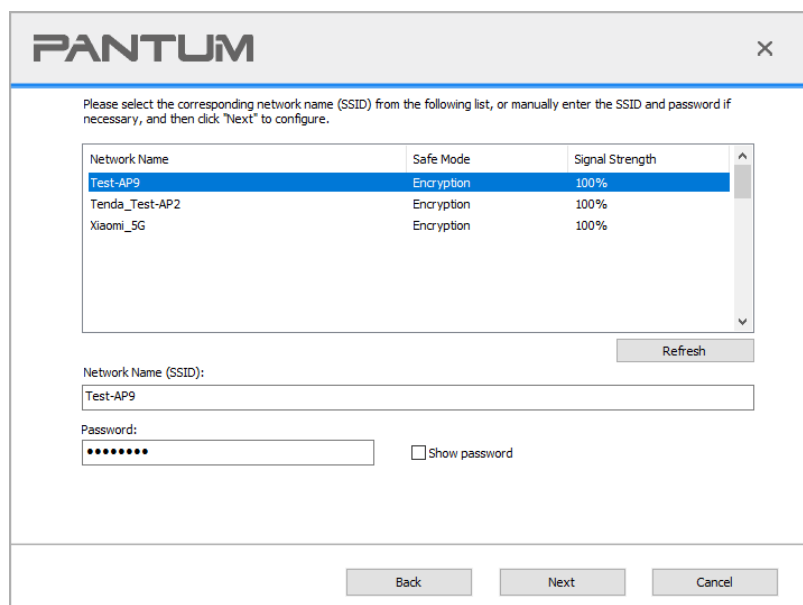

The screenshot shows a PANTUM window titled "PANTUM" with a close button (X) in the top right corner. The main content area contains the following text and elements:

- Text: "Please select the corresponding network name (SSID) from the following list, or manually enter the SSID and password if necessary, and then click 'Next' to configure."
- Table of detected networks:

Network Name	Safe Mode	Signal Strength
Test-AP9	Encryption	100%
Tenda_Test-AP2	Encryption	100%
Xiaomi_5G	Encryption	100%

- Text: "Network Name (SSID):" followed by a text input field containing "Test-AP9".
- Text: "Password:" followed by a password input field with masked characters (dots) and a checkbox labeled "Show password".
- Buttons: "Back", "Next", and "Cancel" at the bottom.





**Note:** • Encryption method:

- 1) None: There is no encryption method used.
  - 2) WPA/WPA2: it is the pre-shared key (PSK) of Wi-Fi protected access which connects wireless device and access point via TKIP or AES encryption (WPS-Personal). The working length of WPA/WPA2 is within the PSK of 8-63 characters.
- The display password is not ticked by default; if it is ticked, all passwords input can be seen in clear text.
  - Some models can automatically match the encryption method, no manual selection is required.

2.2 The computer is not connected to wireless network Input the SSID (case sensitive) and password of access point (wireless router) in the interface below. Complete configuration according to interface prompt.

**PANTUM** [Close]

1. Click "Wireless network information page" to get the name of network available for the printer. Skip this step if you've already known such name.

Printing wireless network information page

2. Please enter wireless network user name and password.

Network Name (SSID):

\_\_\_\_\_

Password:

\_\_\_\_\_

Show password

Back Next Cancel



- Note:** • If you do not know the SSID of access point (wireless router), please click "Print Wireless Network Information Page" to view the SSID of the needed access point (wireless router).
- If the printer cannot be used normally after wireless network setup is finished, please install the drive again.

### 3. Use WPS connection .

Select “No, I don't have a USB cable” in the interface below and then click “Next”.

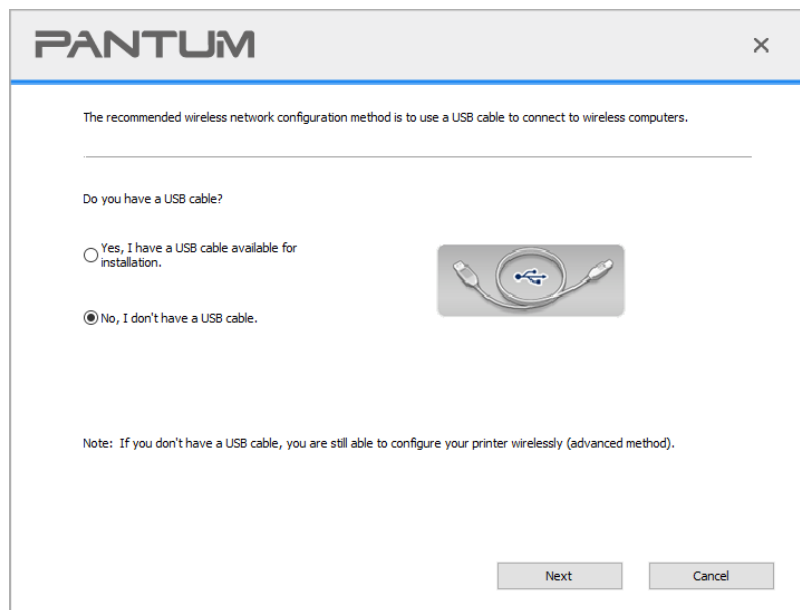

1) Use WPS method to perform steps below to start wireless network on printer. (Please refer to [Chapter 5.1.2](#) for detailed WPS configuration)

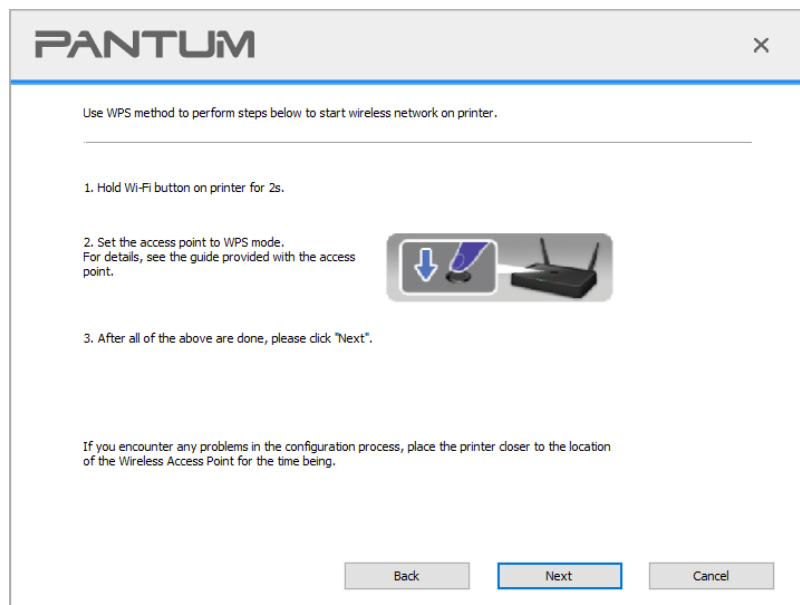

2) Judge if the printer is successfully connected according to the status of Wi-Fi indicator on printer. If configuration failed, please click “Previous” to configure again; if configuration succeeded, please click “Done” to complete configuration.

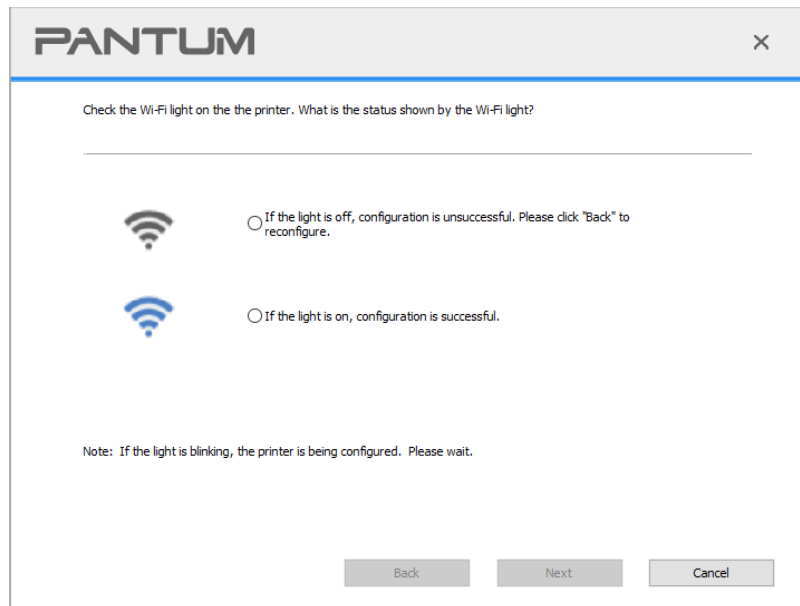

**Note:** • If the printer cannot be used normally after wireless network setup is finished, please install the drive again.

## 5.1.2. Wi-Fi Protected Setup (WPS) setup

If the access point (wireless router) supports Wi-Fi Protected Setup (WPS), the Wi-Fi key on the control panel of printer and WPS key on access point (wireless router) can be pressed in order to connect the printer to wireless network.

### 5.1.2.1. Preliminary preparations

1. The access point (wireless router) supports Wi-Fi Protected Setup (WPS).
2. A printer that has wireless network function.

### 5.1.2.2. Wi-Fi Protected Setup (WPS) method

1. Turn on the power of printer and access point (wireless router).
2. Make sure the printer is in ready state.



**Note:** • If the printer is in sleep mode, it can be woken up by pressing any key on the control panel of printer.

3. Press the “Wi-Fi key” on the control panel of printer for more than 2s until the blue Wi-Fi indicator of printer blinks, and then release pressing.
4. Press the WPS key on access point (wireless router) within 2min and then release it.
5. When the access point (wireless router) and printer start to connect, the blue Wi-Fi indicator of printer starts to blink. The blue Wi-Fi indicator of printer will be normally on after successful connection.

If the connection is not established after more than 2min, the printer will return to its ready state, the Wi-Fi indicator will be off and Wi-Fi Protected Setup (WPS) connection will fail. If it is needed to connect again, please repeat steps 3-4 above.



---

**Note:** • After successful Wi-Fi Protected Setup (WPS) connection, please install a driver if you want to print via wireless network.

---

### 5.1.3. How to disable the Wi-Fi network connected

Connect the wireless network in infrastructure mode by the steps above. If connected, the Wi-Fi light on the control panel is normally on. Press and hold this button for more than 2s to disconnect from Wi-Fi network (Wi-Fi light will be off).

## 5.2. Wi-Fi hotspot mode

You can establish a connection between a wireless network-enabled computer and a wireless network-enabled printer without using an access point (wireless route).

### 5.2.1. Preliminary preparations

1. Printer with Wi-Fi hotspot function.
2. Computer with wireless network function.

### 5.2.2. Wi-Fi Hot Connection

Before connecting the printer hotspot, enable the Wi-Fi hotspot function of the printer by tapping the "Wi-Fi" button on the printer panel.



---

**Note:** • Tap the "Wi-Fi" button on the printer panel, and the printer will automatically print the "Mobile device Wi-Fi connection guide page" for Wi-Fi connection of a mobile device.

---

### 5.2.3. Wi-Fi Hotspot Configuration

When the wireless hotspot of printer is active, the user can connect to it directly by searching. The wireless hotspot is enabled by default, and the default password is "12345678". The printer-specific SSID and password can be obtained from Wi-Fi Configuration Information Page, which can be printed out by selecting Print Wi-Fi Configuration. After establishing the connection, the configuration can be completed according to the Web configuration method.

## 5.3. Wireless network setup FAQs

### 1. The printer is not found.

- If the power of computer, access point (wireless router) or printer is turned on.
- If the computer is connected to printer with USB cable.
- If the printer supports wireless network connection.

### 2. SSID cannot be found when network is connected

- Inspect if the power switch of access point (wireless router) is turned on.
- The printer cannot find the SSID of the access point (wireless router) you need to connect, please check the SSID of access point and try to connect again.
- Every time when the setup of access point (wireless router) is changed, you must set up the wireless network of printer again.

### 3. Connection failure

- Please inspect if the safe mode and password of access point (wireless router) and printer is correct.
- Inspect the wireless receiving around printer. Signal receiving may be affected if the router is away from the printer or there is an obstacle between them.
- Turn the power of access point (wireless router) and printer off and then restart them and set up.

### 4. The following aspects should be inspected if the printer has problems while they are used in network:

- Inspect if the firewall software blocks communication. If the computer and printer are connected in the same network but they cannot be searched, the communication might be blocked by firewall software. Please refer to the user guide of firewall software to turn firewall off and then try to search the printer again.
- Inspect if the IP address assignment of printer is correct. You can inspect IP address by printing the network setup information page of printer out.
- Please refer to the following steps to check if printer and computer are in the same network:
  - 1) Select "Command prompt" as shown below.
    - a. Windows 8/10 system: Select "Search" button in the Start Menu and input "Command prompt" in search bar, then press the "Enter" button in the keyboard.
    - b. Windows 7/Vista/XP system: click "Start" menu-"All procedures"-"Attachment"-"Command prompt".
  - 2) Input ping and your printer IP address in popup window, and press "Enter" button.  
For example: ping XXX.XXX.XXX.XXX("XXX.XXX.XXX.XXX" is printer IP address)
  - 3) If RTT is indicated in the window, that is to say your printer and computer are in the same network. If RTT is not indicated in the window, please refer to [Chapter 5](#) to re-configure the printer wireless network.



---

**Note:** • Please refer to the user guide or consult the manufacturer for information related to access point (wireless router).

---

## 6. Mobile Print/Scan/Fax (for models with Wi-Fi function only)

### 6.1. "Pantum" APP

Pantum APP is a free application with mobile printing, scanning and faxing functions, allowing you to print or fax photos, files, pages and scan photos or files directly from mobile terminal. Your printer may not support all of above mentioned functions, so please select relevant function of Pantum APP for use according to your printer type. Please be sure the application has been installed and connected to wireless network properly before use.

#### 6.1.1. Operating systems supported

"Pantum App" is suitable for Android 5.1-10.0 and iOS 9.0-14.0 system versions.

#### 6.1.2. How to download Pantum APP

How to download it for Android mobile device:

1. You can download it from its official website <http://www.pantum.com> > Service & support > Driver download > Select printer model > Download and install.
2. You can use Google Play Store > Apps > to search Pantum Mobile Printing > Download and install.

How to download it for iOS mobile device:

Click the App Store icon > Search interface > input "PANTUM" or "Pantum print" in the search bar > Download and install on the interface of iOS device to download.

#### 6.1.3. How to use this "Pantum" APP

##### 6.1.3.1. For Android Devices

###### 6.1.3.1.1. Preliminary preparations

1. A printer that has wireless network function.
2. Android mobile device.

###### 6.1.3.1.2. Operation steps

1. Turn on printer power.
2. For an Android mobile device, tap the "PANTUM" icon on the main screen to enter the first interface of "PANTUM".
3. Select the connection method according to your habit to connect the printer.
4. Select the function you want and then do relevant settings to meet your functional demands.

---

 **Note:** • If failure of operation, please check if your Android mobile device has access to the wireless network into which your printer is connected.  
• If the Android device cannot detect any printer, please inspect if power of the printer is turned on and if the printer is turned on.  
• For more details, please refer to the mobile print user guide attached.

---

### 6.1.3.2. For iOS Devices

#### 6.1.3.2.1. Preliminary preparations

1. A printer that has wireless network function.
2. iOS mobile device.

#### 6.1.3.2.2. Operation steps

1. Turn on printer power.
2. For an iOS mobile device, tap the “PANTUM” icon on the main screen to enter the first interface of “PANTUM”.
3. Select the connection method according to your habit to connect the printer.
4. Select the function you need and set it up to meet your function needs.

---

 **Note:** • If printing fails, please inspect if the iOS device is connected to the wireless network where the printer is connected to.  
• If the iOS mobile device did not detect any printer, check whether the printer is powered on and the printer is turned on.  
• For more details, please refer to the mobile print user guide attached.

---

## 6.2. Mopria mobile print

Mopria mobile print requires installing Mopria Print Service on the Android device. You can print photos, emails, webpages and files.

### 6.2.1. The operating systems and applications which support Mopria mobile printing

1. Mopria mobile printing is suitable for Android 4.4 or higher version.
2. Mopria mobile printing is supported by applications, e.g. Microsoft Office 1.01(16.0.4201.1006) or higher version, Adobe Reader (V6.7.1) or higher version.

For more information about applications which support Mopria printing, please visit:

<http://mopria.org/spotlight-wall>

### 6.2.2. How to download Mopria Print Service

1. Download Mopria Print Service from Google Play and install it on the Android device.
2. For Chinese users, please download the Mopria printing service at <http://cn.mopria.org> for downloading and installing this APP.

### 6.2.3. Preliminary preparations

1. A printer that has wireless network function.
2. Android mobile device.

## 6.2.4. How to use Mopria mobile printing

Before printing, please set the Mopria print service as "ON".

1. Tap the "settings" of the Home Screen on Android mobile device, and select "print".
2. Set the "Mopria print service" as "ON".

All other printing plug-ins should be shut down when you use Mopria mobile printing function.

The printing steps may varied by applications, taking Adobe Reader as an example for explanation.

1. Turn on printer power.
2. Connect the Android mobile device with wireless network of the printer (Please refer to [Chapter 5](#) for how to connect).
3. Open the files you need to print with Adobe Reader on the Android device.

4. Click .

5. Tap "print".

6. Please make sure the Pantum printer is selected.

If you selected other printer (or failed to select any printer), please tap the pull-down menu of printer, and select your Pantum printer.

7. Set printing parameters, e.g. print pages.
8. Tap "print".

---

 **Note:** • If printing fails, please inspect if the Android device is connected to the wireless network where the printer is connected to.  
• If the Android device cannot detect any printer, please inspect if power of the printer is turned on and if the printer is turned on.

---

## 6.3. AirPrint mobile print

Only printers that support AirPrint function can realize AirPrint printing. Please check if there is AirPrint mark on the packaging of the printer, in order to identify if the printer supports AirPrint function.

### 6.3.1. Operating systems supported by AirPrint mobile print

Applicable to iOS 9.0 or higher versions.

### 6.3.2. Preliminary preparations

1. A printer that has wireless network function.
2. iOS device mobile printing.



### 6.3.3. How to use AirPrint mobile printing

The printing steps may varied by applications, taking PDF as an example for explanation.

1. Turn on printer power.
2. Connect the iOS mobile device with wireless network of the printer (Please refer to [Chapter 5](#) for how to connect).
3. Open the files you need to print in the format of PDF on the iOS device.
4. Click .
5. Tap "print".
6. Please make sure the Pantum printer is selected.

If you select other printers (or no printer), please click printer option and then select your Pantum printer.

7. Set printing parameters such as number of copies to print.
8. Tap "print".



- Note:**
- If printing fails, please inspect if the iOS device is connected to the wireless network where the printer is connected to.
  - If the iOS device cannot detect any printer, please inspect if power of the printer is turned on and if the printer is turned on.
-

# 7. General Settings

This chapter mainly introduces some general settings of the menu on the control panel.

## 7.1. System Settings

### 7.1.1. Toner Save Setting

Users can select Toner Save Setting to lower the cost of printing. When the Toner Save mode is "On", the output color of the copy will be lighter. Default Setting is "Off".

1. Press "Menu" button to enter the menu interface.
2. Press direction pad "▲" or "▼" to select "System Settings" and press "OK" button.
3. Select "Toner save set" by pressing "▲" or "▼", and press "OK" to enter the toner saving mode.

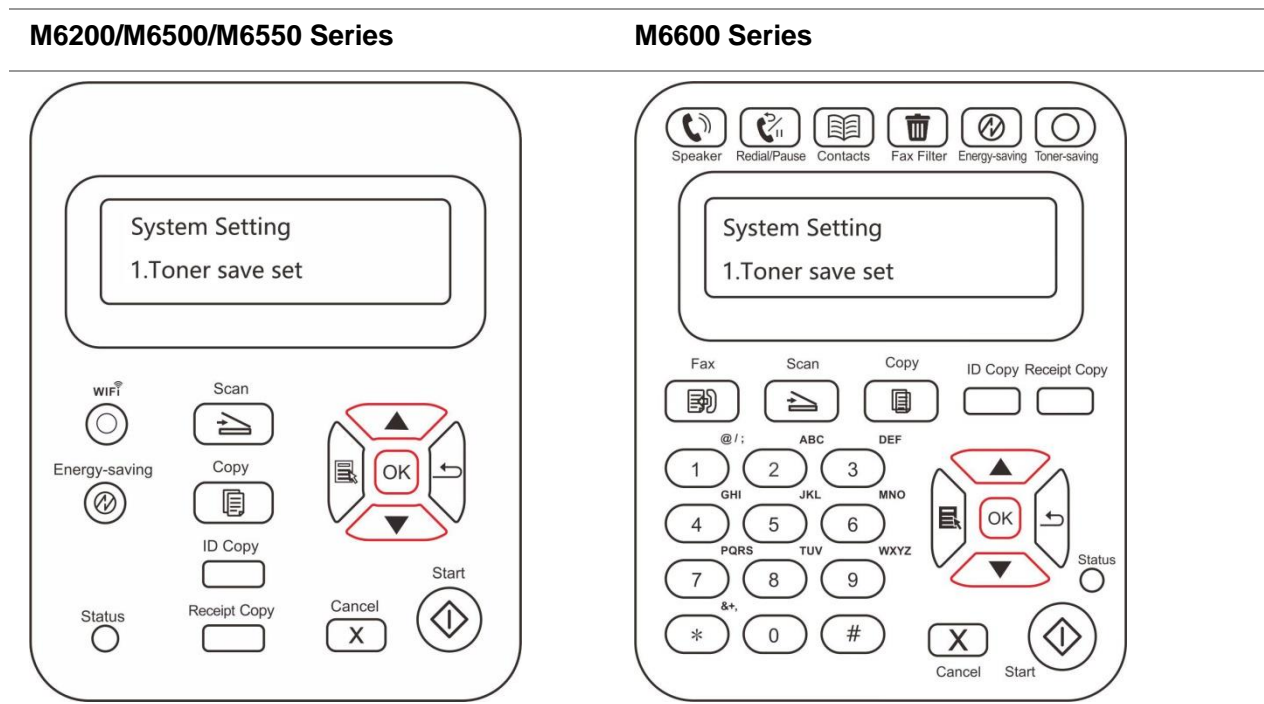

**Note:** • For non-Wi-Fi Model Printer, the Wi-Fi button works as one-key toner saving button.  
• When this menu is placed on the bottom interface of selecting "Close/Open", symbol "\*" of the options displayed in the menu will not update in time after changing toner save setting via one-key toner saving button. Users need to go back to the previous menu to re-enter this menu, the changed Toner Save Setting information will be displayed.

## 7.1.2. Language Setting

"Language Setting" is used to select the language to be displayed on the control panel.

1. Press "Menu" button to enter the menu interface.
2. Press direction pad "▲" or "▼" to select "System Setting" and press OK button.
3. Press "▲" or "▼" to select "Language set" and then press "OK" to do language setting.

### M6200/M6500/M6550 Series

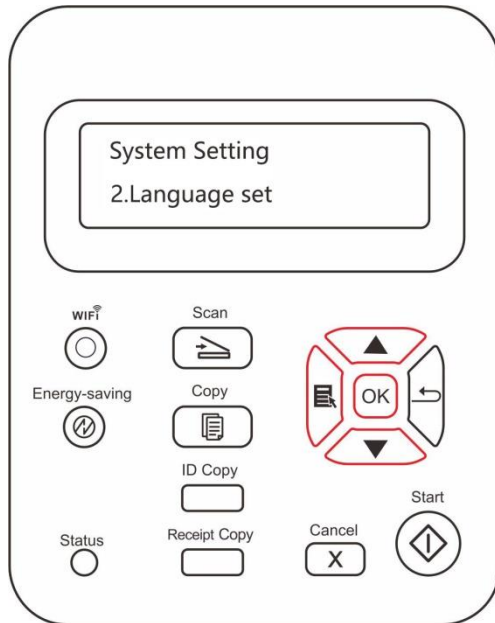

### M6600 Series

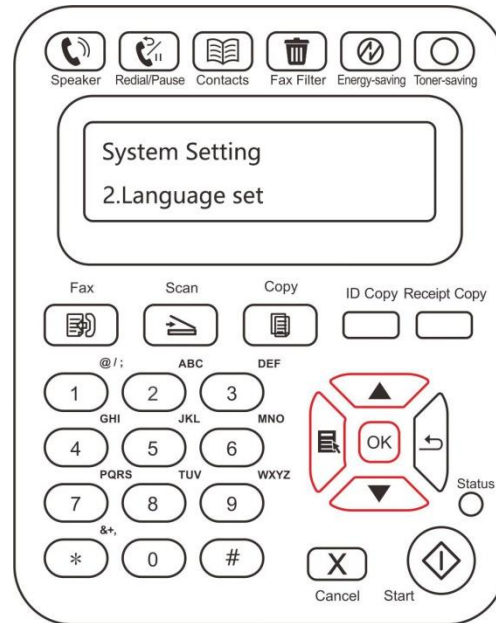

 **Note:** • Product's actual region determines the Language Setting.

### 7.1.3. Restore to Factory Settings

"Restore Factory Settings" is used to restore the default settings of the printer.

1. Press "Menu" button to enter the menu interface.
2. Press direction pad "▲" or "▼" to select "System Setting" and press OK button.
3. Select "Restore set" by pressing "▲" or "▼", and then press "OK" to restore factory settings.

#### M6200/M6500/M6550 Series

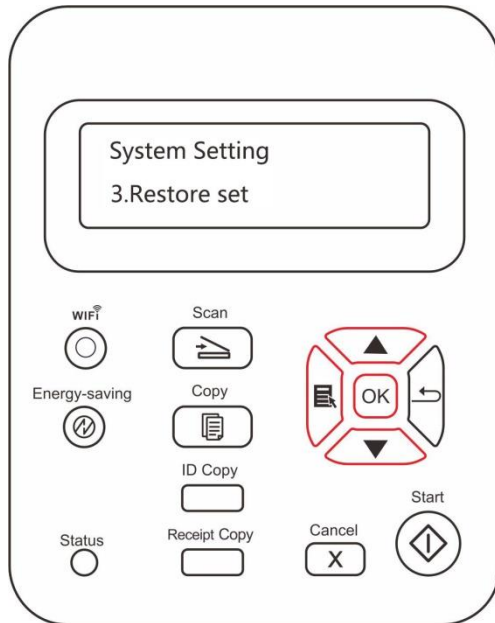

#### M6600 Series

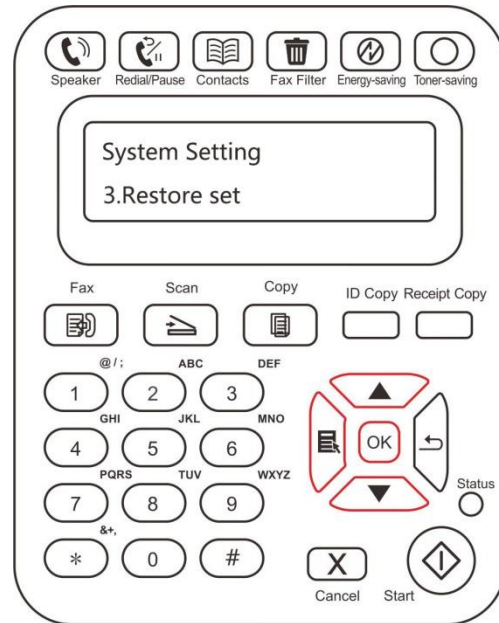

## 7.1.4. Sleep Time Setting

Set the Sleep Mode to lower the power consumption. Sleep Time Setting allows you to select the idle time before the device enter into Sleep Mode. The default idle time is 1 minute.

1. Press "Menu" button to enter the menu interface.
2. Press direction pad "▲" or "▼" to select "System Setting" and press OK button.
3. Press direction key "▲" or "▼" to select "Sleep time set" option, and press "OK" key to set the corresponding sleep time.

### M6200/M6500/M6550 Series

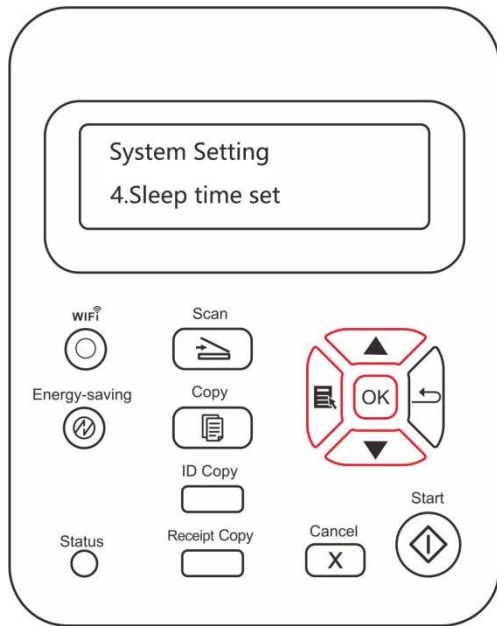

### M6600 Series

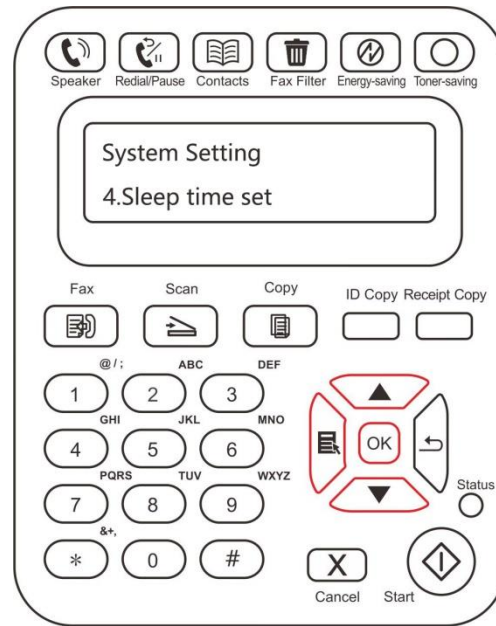

 **Note:** • When the printer is in dormant status, you can wake it up just by pressing Power Saving button, sending print/scan/Fax task, or opening or closing the output bin.

## 7.1.5. Auto shut-off setting

"Auto shut-off setting" to set off condition and off delay of printer.

1. Press "Menu" button to enter the menu interface.
2. Press direction pad "▲" or "▼" to select "System Setting" and press OK button.
3. Press direction key "▲" or "▼" to select options of "Auto off set", press "OK" to set off condition and off delay.

### M6200/M6500/M6550 Series

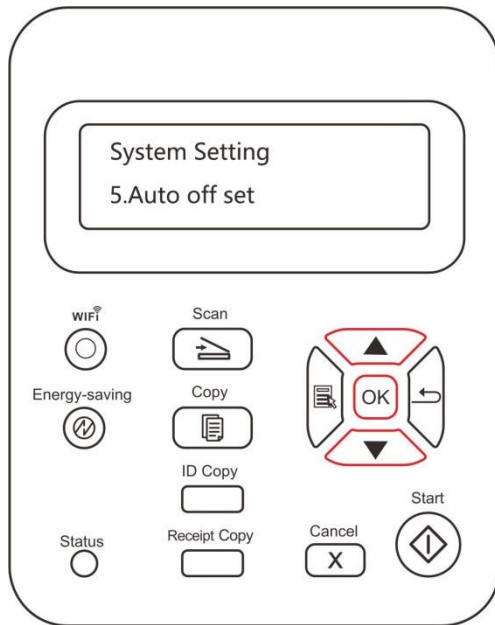

### M6600 Series

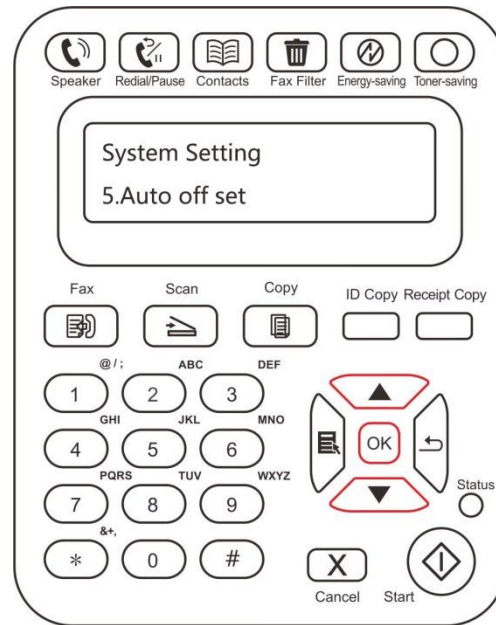

 **Note:** Set auto off condition:

- Shutdown under no-port state (default configuration): no port is connected, Wi-Fi function deactivated, printer is under standby or sleep mode.
- Shutdown under idle state: the printer is under standby or sleep mode.
- If auto off condition is satisfied, printer will be off at the preset time.
- After printer is off, power consumption is 0.5W or lower.
- Individual countries (or regions) do not support auto off setting.
- Default automatic shutdown time: 10 hours

## 7.2. Network Settings

You can view or set the network status through Network Settings.

1. Press "Menu" button to enter the menu interface.
2. Navigate to "Network Set" option and press "OK" to configure the network.

### M6200/M6500/M6550 Series

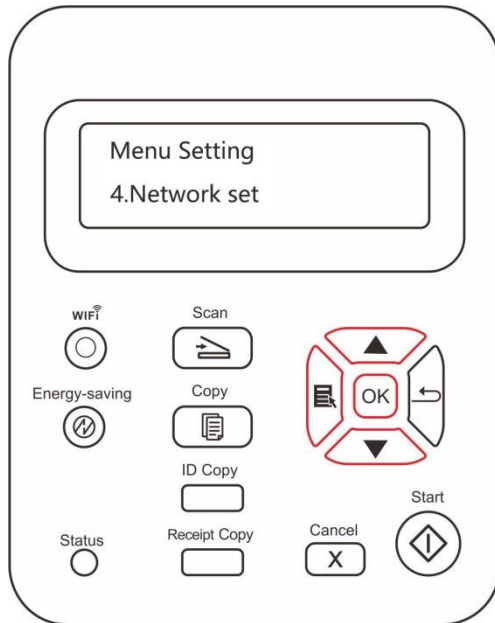

### M6600 Series

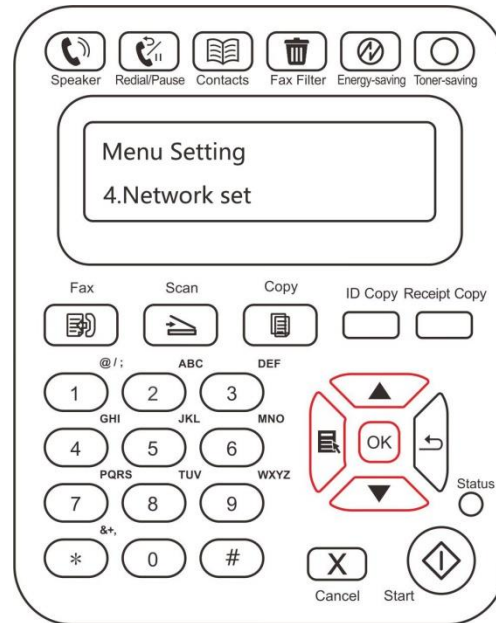

## 7.3. Network Information

Users can check the network status through Network Information.

1. Press "Menu" button to enter the menu interface.
2. Navigate to "Network Info" option to check the relevant information on the network.

### M6200/M6500/M6550 Series

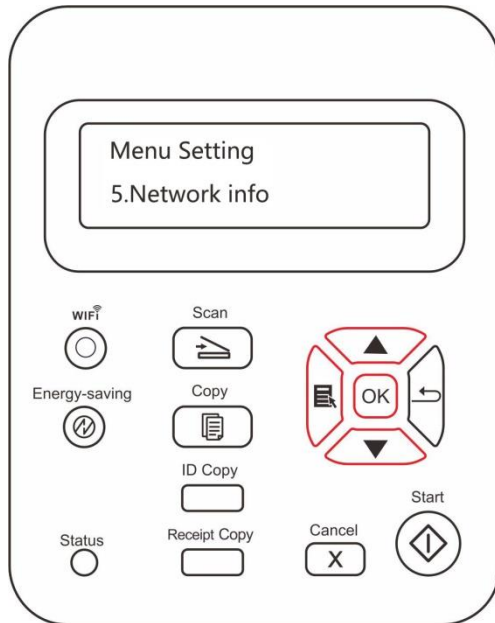

### M6600 Series

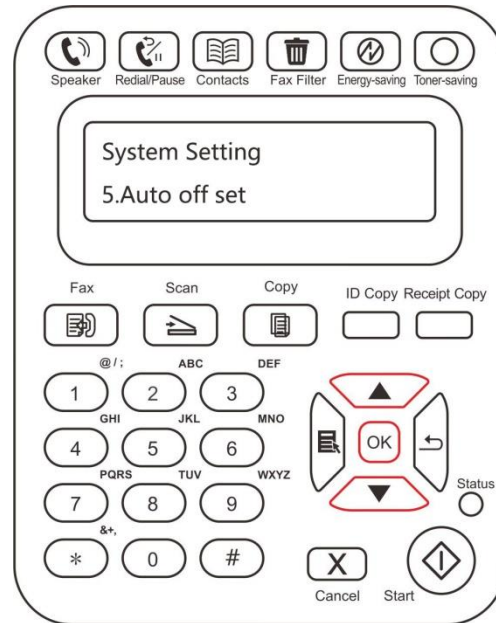



## 7.4. Information report

You can print information report by operating control panel. These pages can help you to learn about product information, and diagnose and solve product failures.

1. Press "Menu" button to enter the menu interface.
2. Press "▲" or "▼" to select "Info.report".
3. Press "OK" key to enter information report print. You can print product report according to needs.

### M6200/M6500/M6550 Series

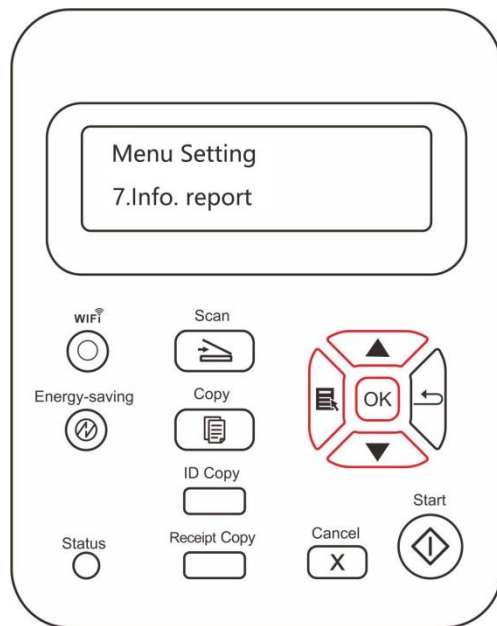

### M6600 Series

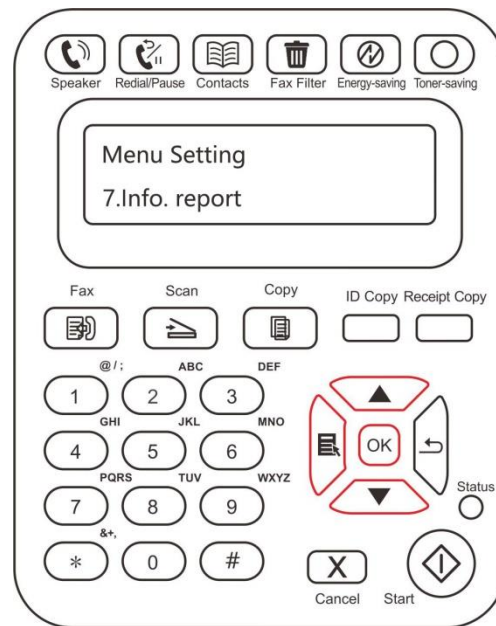







Printable product reports include Print Demo Page, Print information Page, Print Menu Structure, Print Menu Setting, Print network configuration, Print network Service, Print mail address, Print Group Mail, Print FTP address, Print Wi-Fi hotspot and Print Wi-Fi Configuration.

 **Note:** • The product report above is the most complete version, and may be different from the product report of model that you actually use.

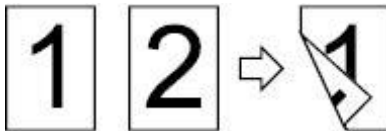
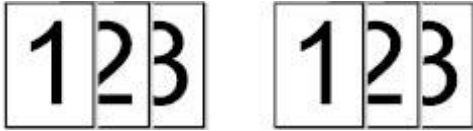
# 8. Print

## 8.1. Print Function

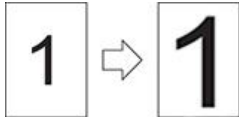
You can set the print function through "Start"->"Device and Printer"- select corresponding printer-right click – set print function in "Print Preferences". Some functions are as follows:

Functions	Diagram
Manual Duplex	
Collate Print	
Reverse Print	
N-in-1	
Poster Print (for Windows Operation System only)	
Zoom Print	
Custom Size	

 **Note:** • You can select the 2 x 2 Poster printing from Layout options in the settings interface to use the poster printing function.  
• You can open the Printing Preferences and click Help button to check the specific function explanation. For information about how to open the help document, see [Chapter 8.2](#).

## 8.2. Open Help Document

You can open the "Printing Preferences" and click "Help" button (for Windows Operation System only). The help document contains the user guide where you can find the information on print settings.

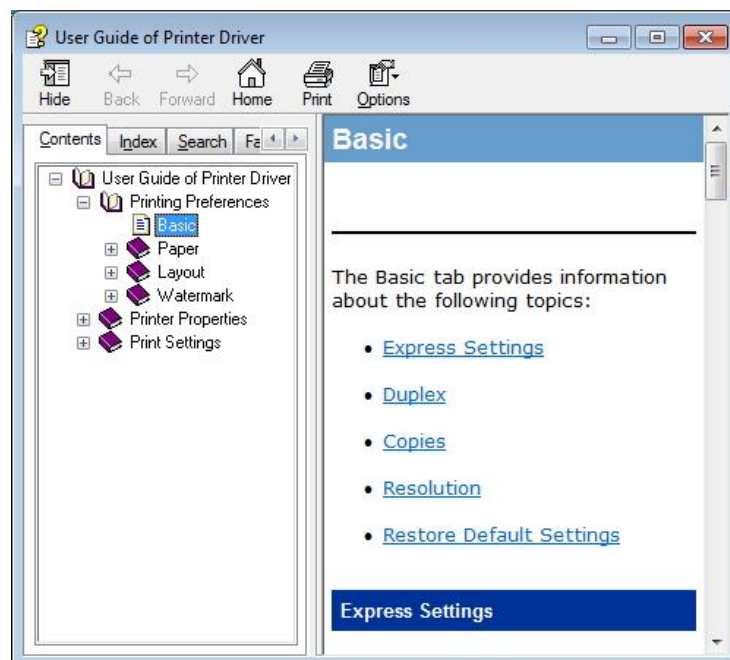
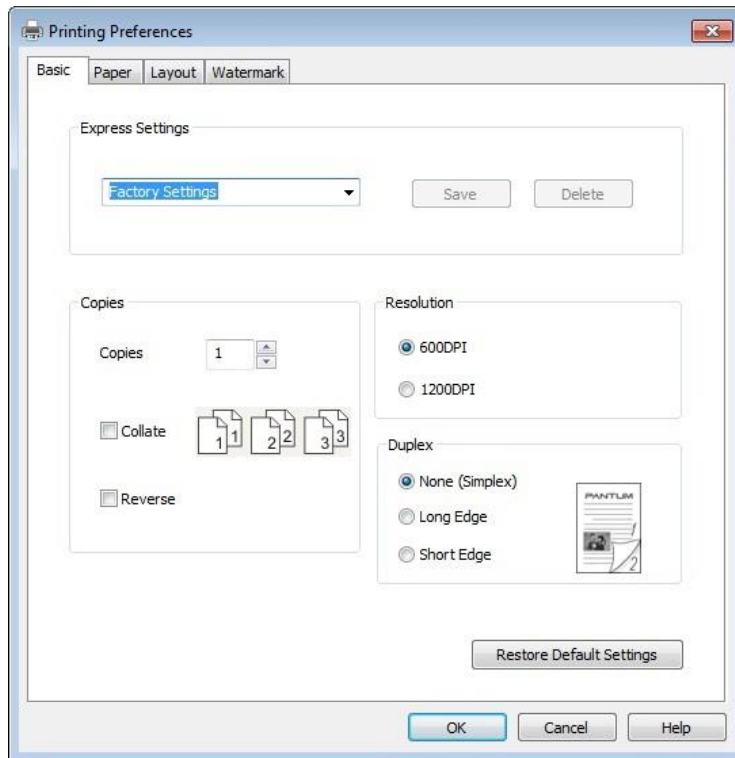

## 8.3. Duplex Print

1. The printer driver supports manual duplex.



---

**Note:**• If the paper is thin, it may wrinkle.

- If the paper is curled, make it flat and put it back into the manual feeder tray.
  - If the manual duplex function causes a paper jam, see [Chapter 13.1](#) for handling it.
- 

2. Ensure that certain amount of paper is loaded into the automatic feeder tray before printing.



---

**Note:**• For loading paper, see [Chapter 2.4](#).

- For the media types that support printing, see [Chapter 2.1](#). It is recommended to use the standard paper.
  - Some paper media are not suitable for the duplex printing. Trying the duplex printing may damage the printer. When "Paper Type" is "Thick Paper" or "Transparent Film", please do not try "Duplex Print". If you choose "Reversed Order" printing in Printing Preferences dialog box, Manual Duplex will not be supported when "2 x 2 Poster" printing.
  - Paper may get jammed or cannot be fed in when the automatic feeder tray is loaded with more than 150 sheets.
- 

3. Printing steps are as follows (for Windows Operation System only) :

a) Open the document to be printed from the application (such as Notepad), and select "Print" from the "File" menu.

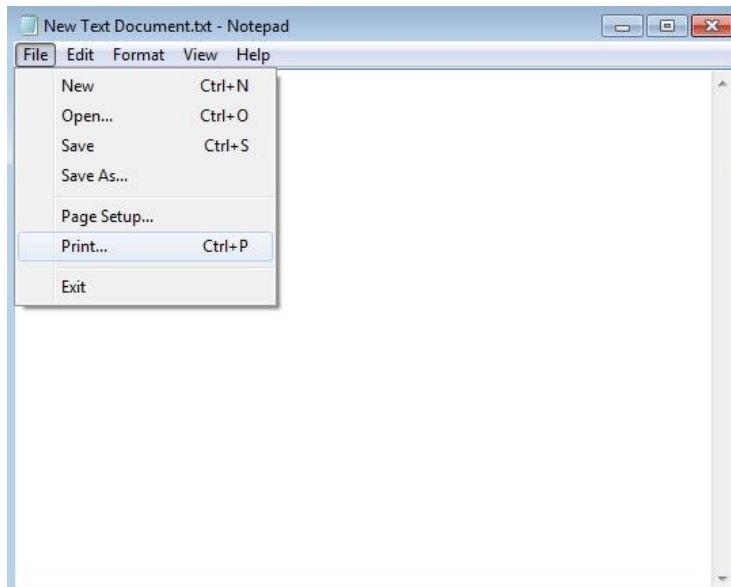

b) Select Pantum printer

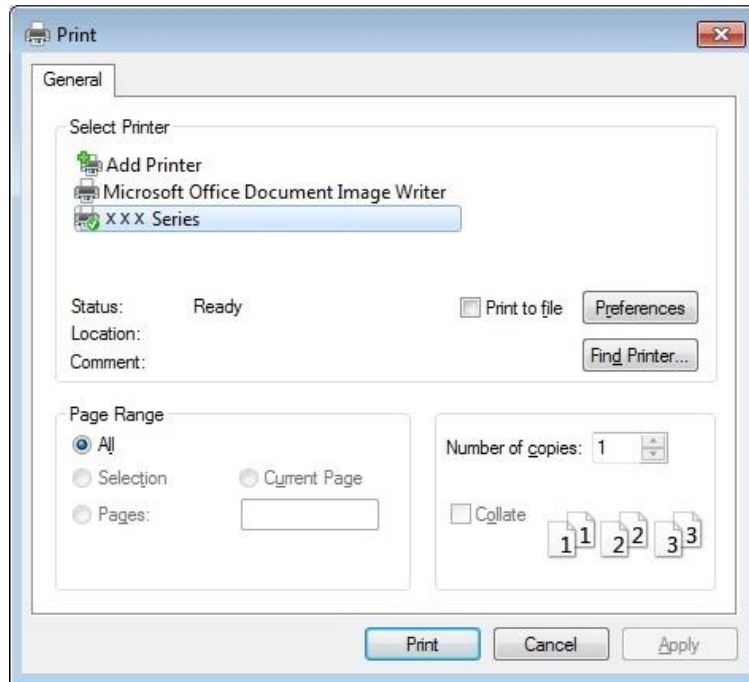

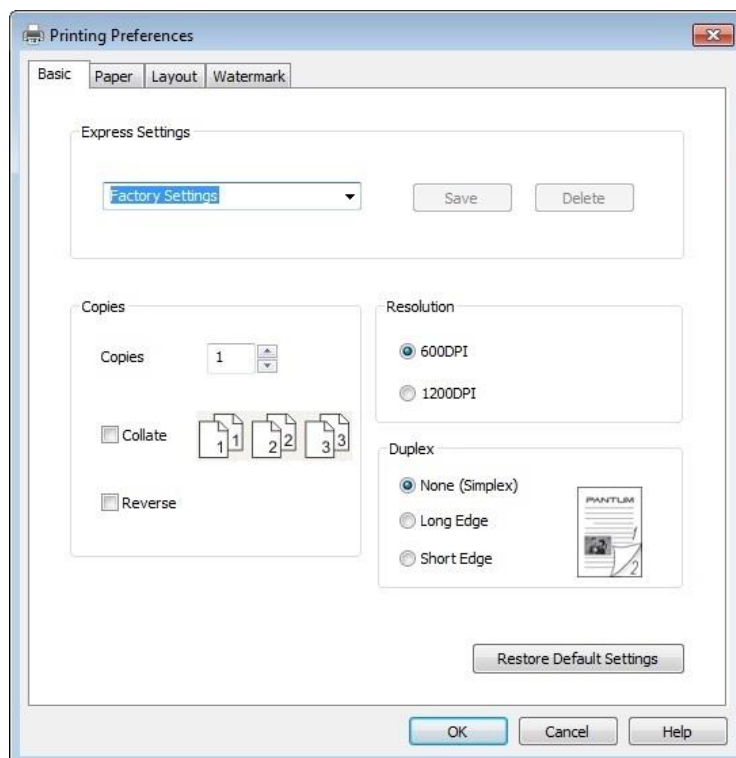

Click "Preferences" to set printing.

c) Set options in "Manual Duplex" of the "Basic" tab and click "OK" after completing the settings.

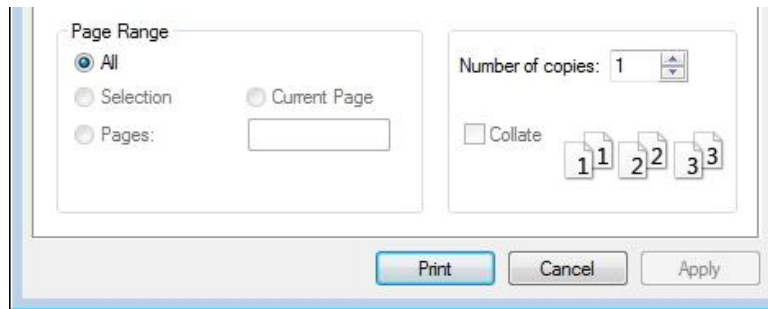

d) Click "Print".



 **Note:** It is recommended to raise the output tray to prevent the paper from sliding out of it. If you choose not to raise the output tray, we recommend that you immediately remove the printed paper output from the printer.

e) Send the print task after choosing Manual Duplex, then the following prompt window will appear, telling you the next specific operations. Interfaces are different depending on the models.

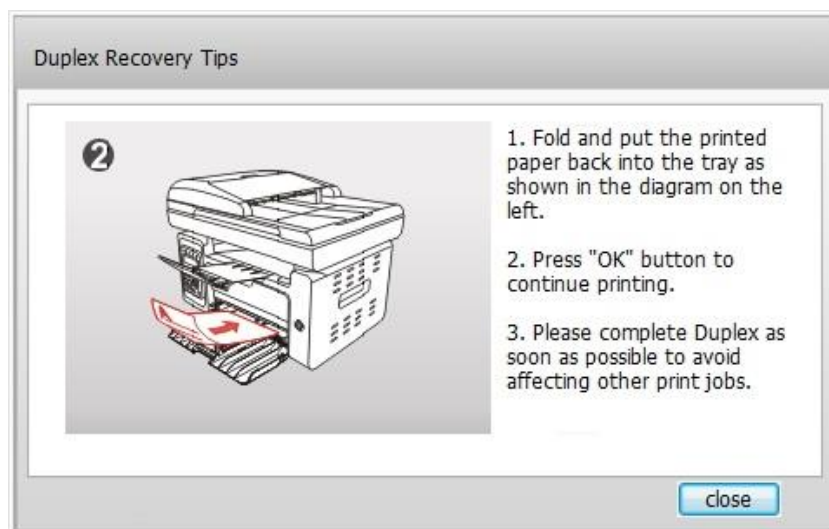
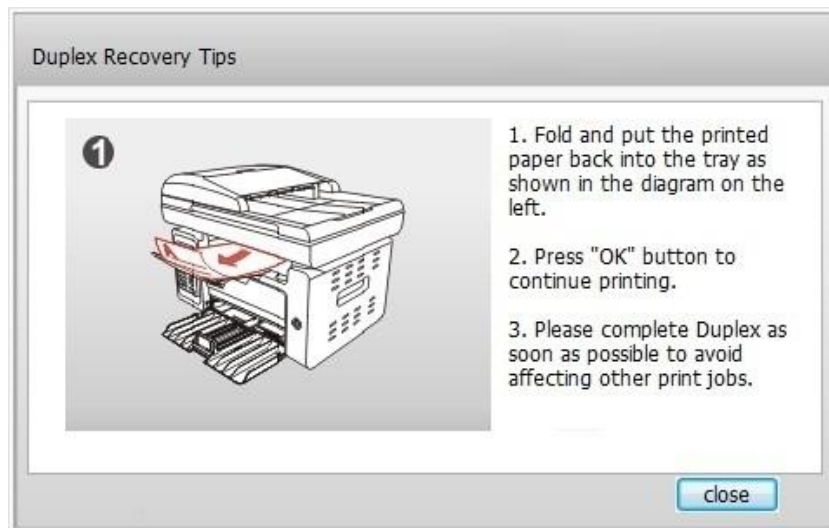

f) After turning over the paper according to the prompt, press "OK" button of the printer to go on printing the other side.

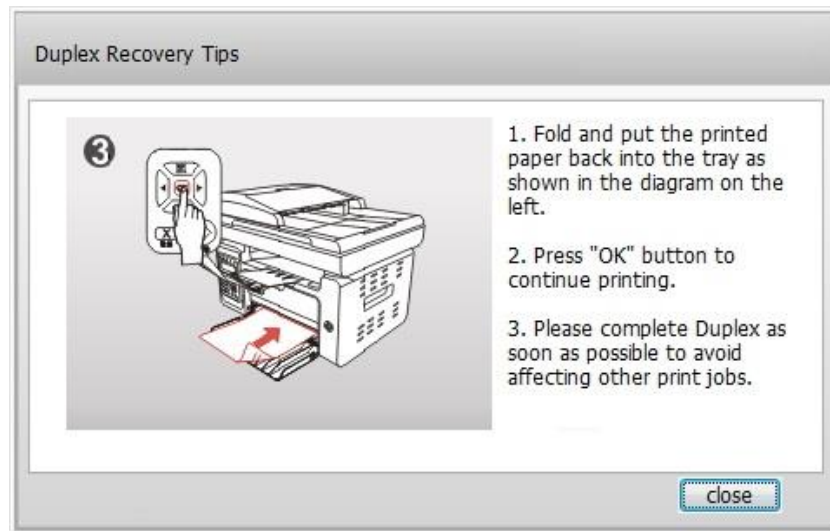

g) You can click "Close" button to close this prompt window, and it will not appear until the next Manual Duplex job comes in.

## 8.4. Cancel Print Job

You can press the Cancel button on the control panel to cancel the print job you want to cancel during the printing process, or cancel the print job in the printing pool.

## 8.5. macOS System Print

Operation Steps:

1. After installing the printer's driver, click on "System Preferences" on the bottom left corner.



2. After the window pops up, click on "Print and Scan".



3. After the window pops up, select "Print".

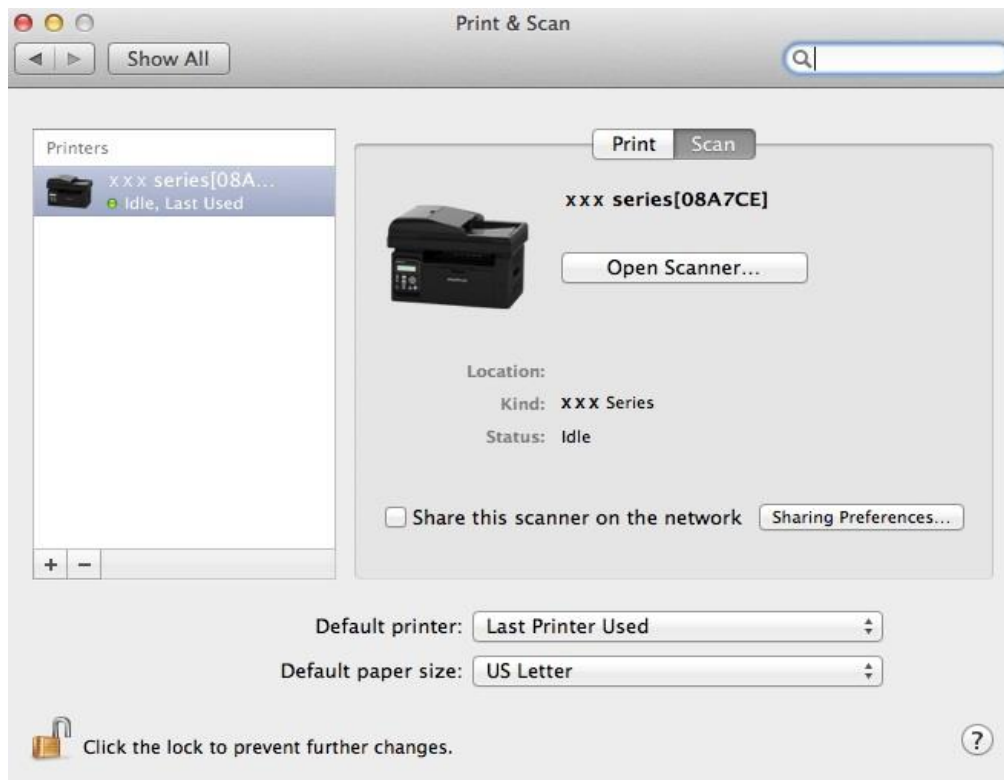



#### 4. Select printer

- 1) For USB Model printer: plug the USB cable, the corresponding printer will automatically show in the left list.
- 2) For NET Model printer: plug the network cable, click on symbol "+" at the bottom of the left list to add printer.



- 3) For Wi-Fi Model printer: select the Wi-Fi icon on the top right corner of the page, click on "Open Network Preferences" in the list.

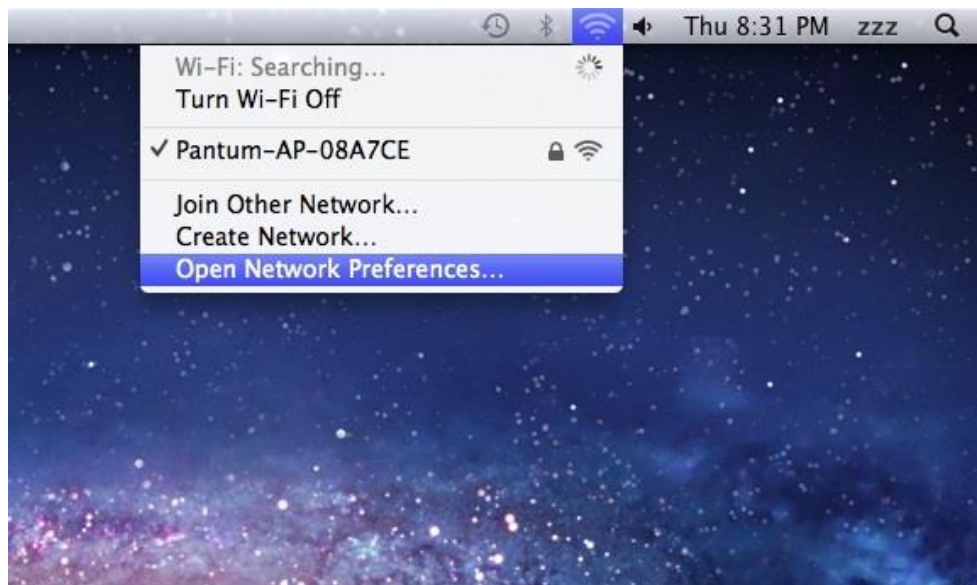

4) After the window pops up, click on SSID.



5) Select the corresponding SSID.

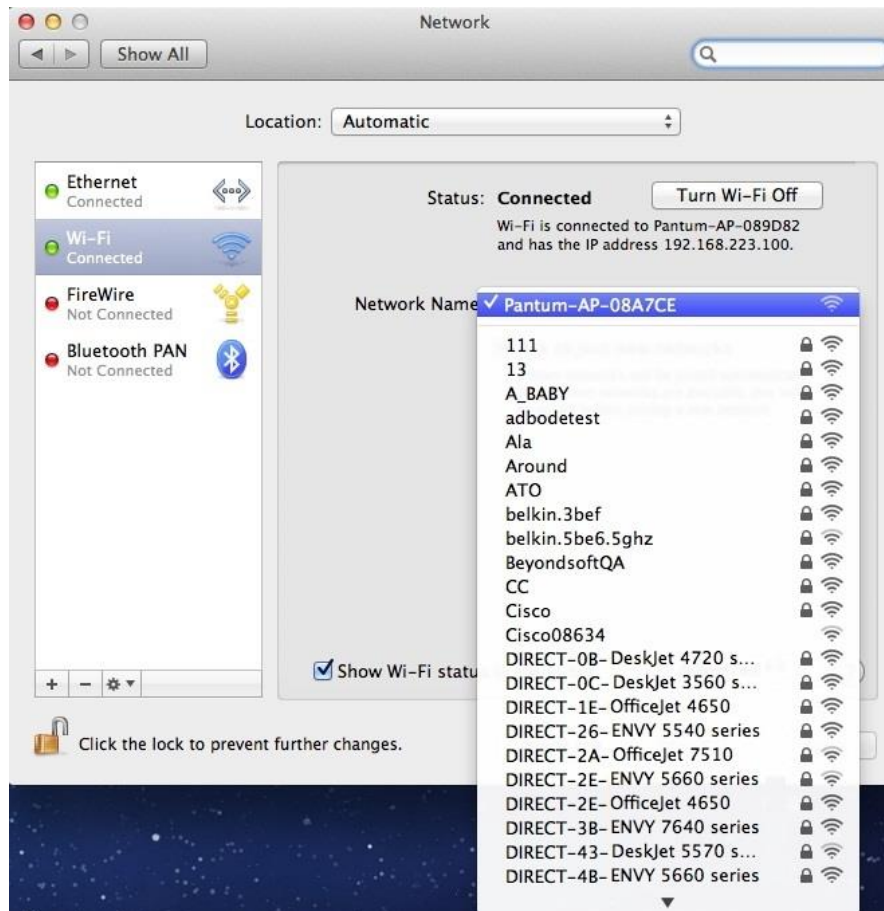

6) Open the document to be printed, click on "Document" – "Print".

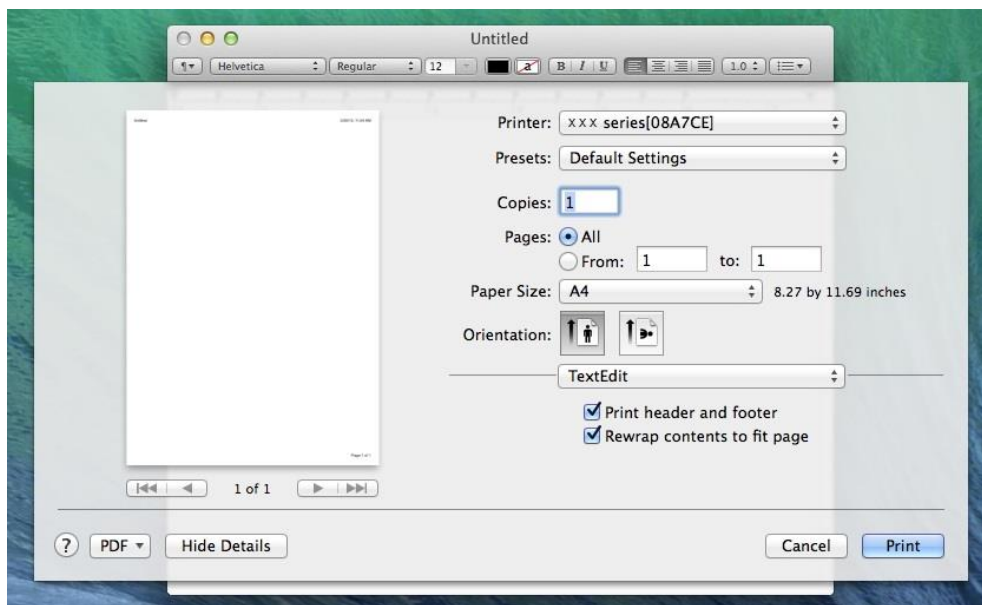

7) After the window pops up, set the printing parameters, and press the "Print" button on the top right corner.

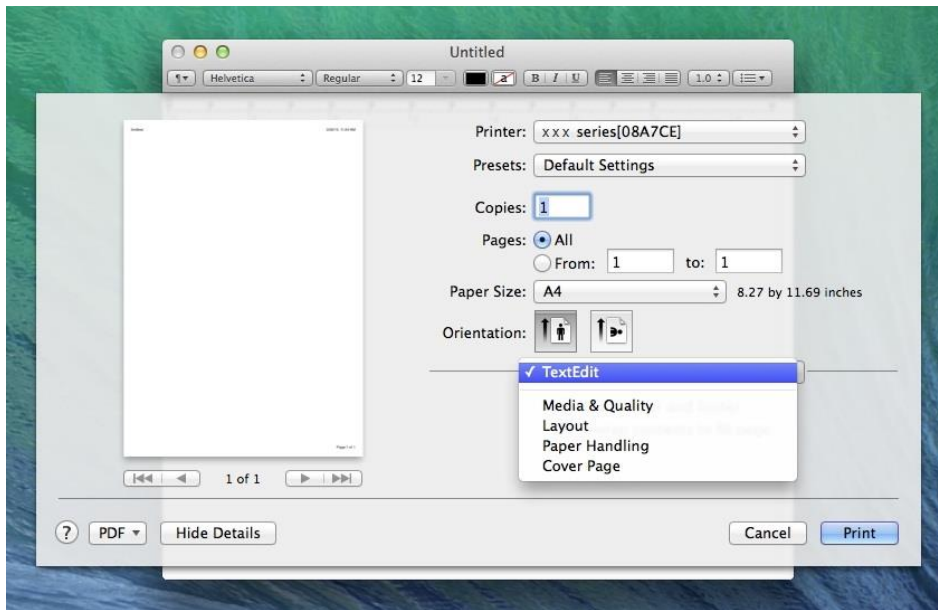

## 9. Copying

### 9.1. Copying function

Copying function		M6200/M6500/ MS6000 Series	M6550/M6600 Series
Common copying	Image quality	●	●
	Intensity	●	●
	Resizing	●	●
	Multipage	●	●
	Clone	●	●
	Poster	●	●
	Collated copy	○	●
	Manual dual-side	○	●
	Paper setting	●	●
ID card copying	Arrangement mode	●	●
	Intensity	●	●
	Paper setting	●	●
Receipt copying	Intensity	●	●
	Paper setting	●	●

(●: inclusive, ○: exclusive)

### 9.2. Copying method

1. Press “copying key”/“ID card copying key”/“receipt copying key” on control panel.
2. Put the original document in automatic document feeder (ADF) (supporting common copying only) with right-side up or put it on glass platform with right-side down (for the method on how to put original document, see [2.5](#)).
3. Set copying quantity with “direction or number key” according to types (99pieces at maximum).
4. Press “Startup key” for copying.

### 9.3. Copying cancel

Press “cancel key” on control panel if canceling copying.

## 9.4. Common copying setting

Change relevant setting with “copying setting menu” for better copying effect.

1. Press “copying key” on control panel and then press “OK key” to enter “copying setting” interface.
2. Press “direction key” to select options and then press “OK key” to enter setting interface.
3. Press “direction key” to select option to be set and press “OK key” to set option.

---

 **Note:** • The image quality, intensity, resizing and paper setting can keep valid after options are set.  
• For multipage, clone, poster, collated copy and manual dual-side setting, set recovery mode as default setting after completing copying, switching panel key or restarting machine.

---

### 9.4.1. Image quality

Select corresponding image quality mode for original document used in order to improve copying effect.

There are 4 modes in total:

**Automatic:** default mode.

**Text+ image:** applicable to original text and image.

**Image:** applicable to original image.

**Text:** applicable to original text.

---

 **Note:**• The image quality mode supports “automatic” mode only after “poster” and “collated copy” are set.

---

### 9.4.2. Intensity

Adjust deep-light copying effect by setting intensity.

Intensity includes “manual” and “automatic adjustment”.

Manual adjustment: light      dark

### 9.4.3. Resizing

When original document is copied, resize image copied.

The resizing includes “fixed” and “manual adjustment” and the default value is 100%.

1. **Fixed resizing:** 141% A5->A4、122% A5->B5、115% B5->A4、97% LTR->A4、94% A4->LTR、86% A4->B5、81% B5->A5、70% A4->A5.

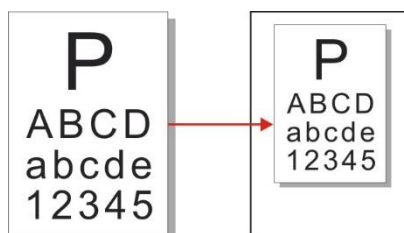

e.g.: 70% A4->A5:

2. “Manual adjustment” applies to copying with glass platform only, the adjustment scope of which is 25%-400% and 5% can be adjusted each time after “direction key” is pressed once.

### 9.4.4. Multipage

2 or 4 pages of texts can be copied on one piece of paper with multipage setting. The multipage includes 3 modes:

Two-in-one:

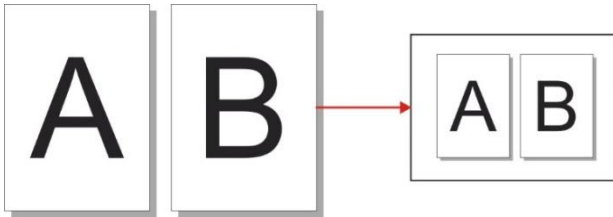

Horizontal four-in-one:

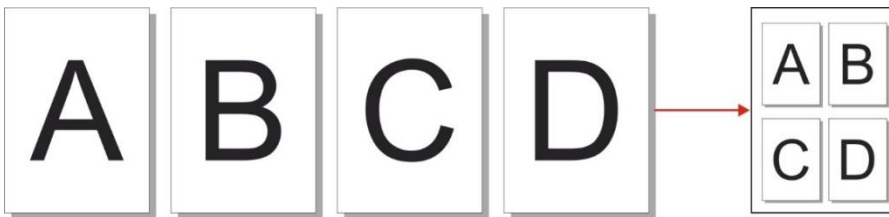

vertical four-in-one:

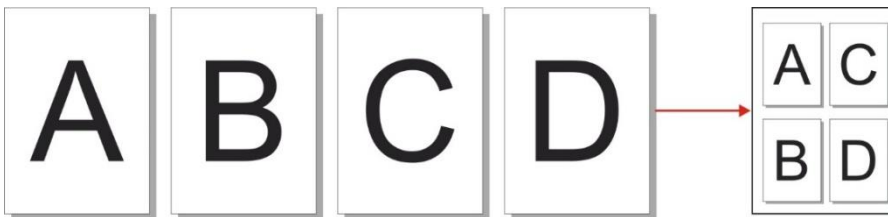

**Note:** • "Multipage" and "resizing function" cannot be set at the same time.

### 9.4.5. Clone

Clone setting enables the printing of many original images on one piece of paper.

The clone copying includes 3 modes:

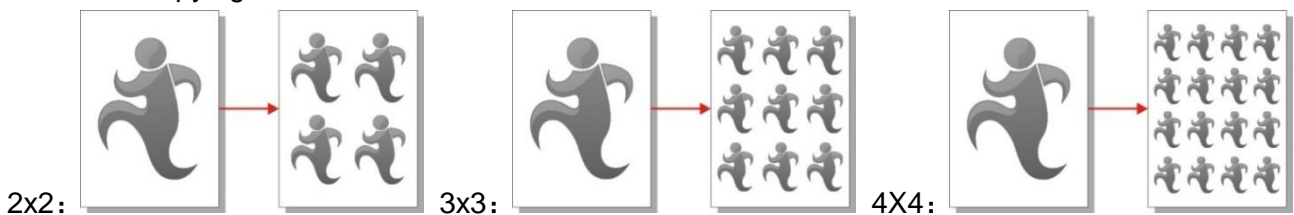

**Note:** • The "clone" and "resizing function" cannot be set at the same time.

### 9.4.6. Poster

Poster setting enables the printing of one piece of original document on several pieces of paper. The poster copying includes 3 modes:

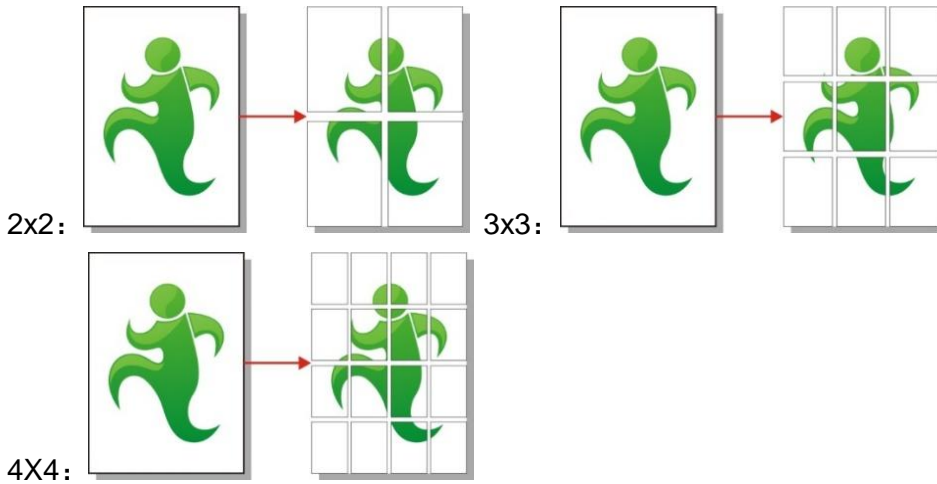

 **Note:** • The “poster” and “resizing function” cannot be set at the same time.

### 9.4.7. Collated copy

The “collated copy” function supports ADF copying only. The collated copy includes 2 modes:

**Open:**

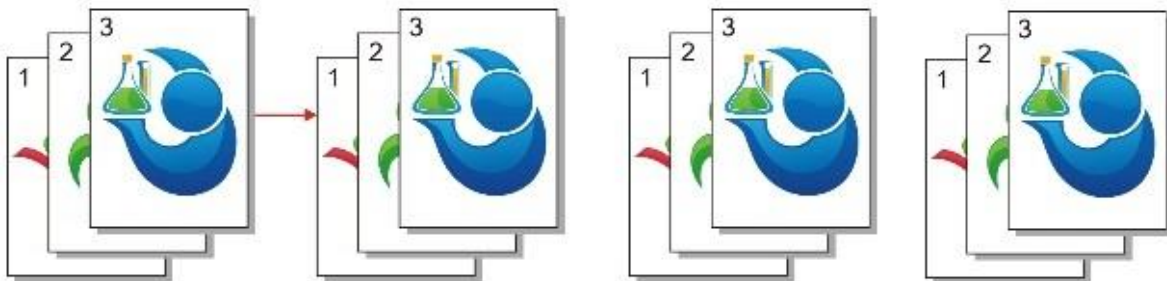

**Closed:**

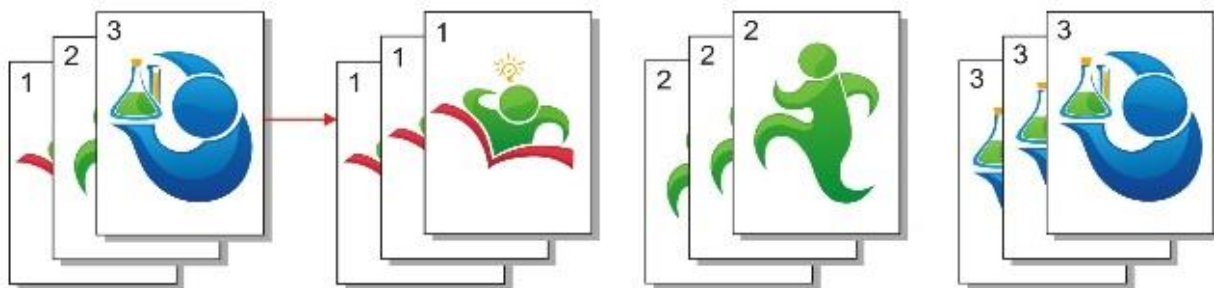



### 9.4.8. Manual dual-side

If the original document is copied on both sides manually, please select ADF feeding mode.

The manual dual-side includes 2 modes:

**Closed:** supporting single side copying.

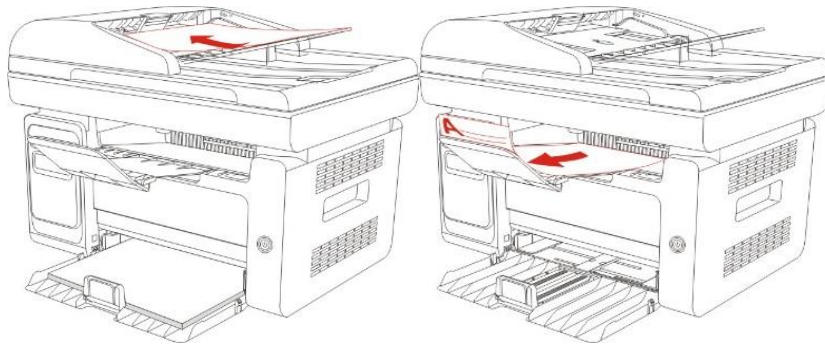

**Open:**

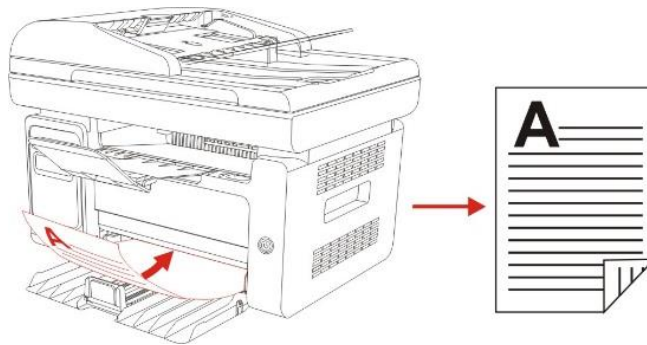

### 9.4.9. Paper setting

By paper setting, you can set suitable paper dimension and type.

**Paper dimension:** A4, Letter, B5, A5, A6, Executive, Legal and Folio.

**Paper type:** common paper, thick paper, envelope paper, film paper, card paper, tagboard and thin paper.



- 
- Note:**
- After “multipage” and “clone function” are set, “paper dimension” supports “A4” and “Letter” only.
  - If original documents are copied with ADF mode, “paper dimension” supports “common paper” only.
- 

## 9.5. ID card copying setting

Change relevant setting with “copying setting menu” for better copying effect.

1. Press “ID card copying key” on control panel and then press “OK key” to enter “copying setting” interface.
2. Press “direction key” to select options and then press “OK key” to enter setting interface.
3. Press “direction key” to select option to be set and press “OK key” to set option.

### 9.5.1. Arrangement mode

There are 4 arrange modes for ID card copying totally:

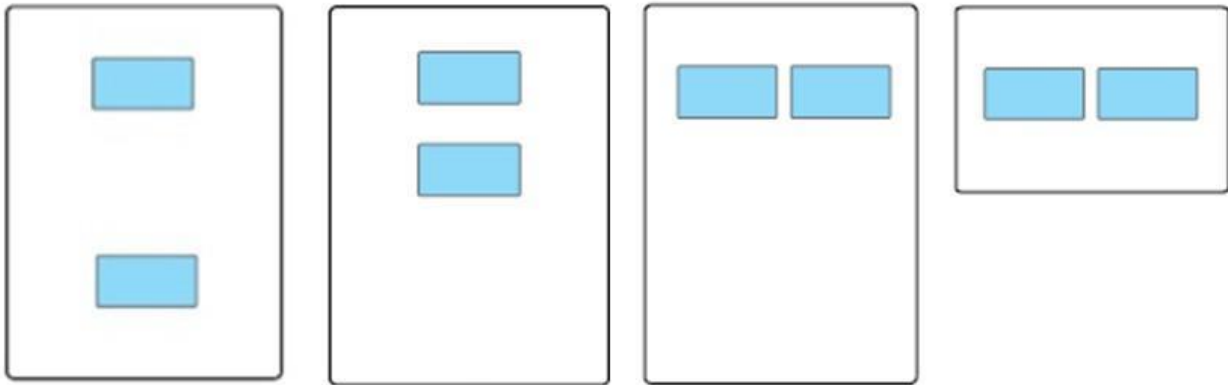

Whole page up-down

Half page up-down

Half page left-right

A5 left and right

Position:

Half page up-down: default mode; put ID card at “orange left half area” of glass platform.

Half-page up-down, half page left-right or long side of A5 paper: put ID card at “blue area” of glass platform.

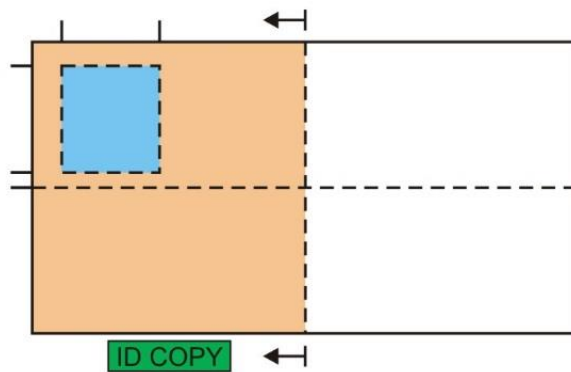

---

 **Note:** • After setting, the arrangement mode can keep valid before startup; after startup, the arrangement mode will recover to default setting.

---

### 9.5.2. Intensity

For intensity setting, see [9.4.2](#).

### 9.5.3. Paper setting

ID card copying supports A4 and Letter paper dimension.

## **9.6. Receipt setting**

Change relevant setting with “copying setting menu” for better copying effect.

1. Press “receipt copying key” on control panel and then press “OK key” to enter “copying setting interface.”
2. Press “direction key” to select options and then press “OK key” to enter setting interface.
3. Press “direction key to select option to be set and press “OK key” to set option.

### **9.6.1. Intensity**

For intensity setting, see [9.4.2](#).

### **9.6.2. Paper setting**

The receipt copying supports A4, Letter, B5, A5, A6 and Executive paper dimension.

# 10. Scan

This printer provides two types of scan: "Push Scan", which means scanning through the printer's Control Panel operations; "Pull Scan" which means scanning through PC terminal scanning the application.

## 10.1. Push Scan

### 10.1.1. Steps for Push Scan with Tablet

This section introduces how to scan documents to the PC (only through USB cable connection) with control panel of the printer. The specific operation steps are as follows:

1. Put the document face down on the glass platen.

---

**M6200/M6500 Series**

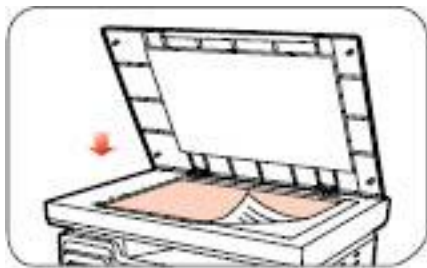

**M6550/M6600 Series**

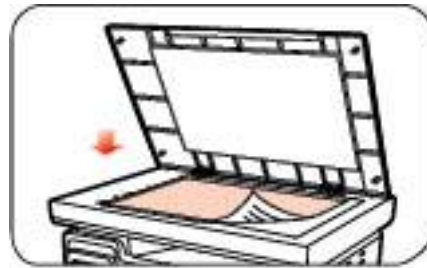

---

 **Note:** • During copying, please do not open the cover to avoid any adverse impact on the image quality.  
• For the information on "Steps of Using Paper and Manuscript", please refer to [Chapter 2.5](#).

---

2. Press Scan on the Control Panel and press direction pad "▲" or "▼" to select "Single Page Scan" or "Merge Scan" to enter into the Scan mode.

---

 **Note:** • For the information on Single Page Scan and Merge Scan, see [10.1.3](#). and [10.1.4](#).

---

3. Press "Start" button to start scanning.

---

 **Note:** • Formats of scanned attachments: network scan supports PDF, TIFF and JPEG formats. Users can select the Save As Type on the panel for the scanned documents.

---

## 10.1.2. Steps for Push Scan with Automatic Document Feeder(ADF)

(For M6550/M6600 Series models only)

1. For information about Manuscript Loading Procedures, see [2.5](#).
2. Press Scan on the Control Panel and press direction pad "▲" or "▼" to select Single Page Scan or Merge Scan to enter into the Scan mode.

 **Note:** • For a single page scanned to PC/E-mail/FTP, you can save it as PDF, TIFF or JPEG.  
• If you choose to scan to PC with N-UP Scan under the ADF scanning mode, the scanned documents will be PDFs by default; For those scanned to E-mail/FTP with N-UP Scan, you can save them as PDF, TIFF or JPEG.

3. Press Start button to start scanning.
4. Paper comes out from the ADF output exit and the scan completes;

## 10.1.3. Single Page Scan

The default scan mode of control panel is Single Page Scan mode.

For the specific steps of scan operation, please refer to [Chapter 10.1](#)see.

## 10.1.4. Merge Scan

When you want to merge multi-page scanned documents into one PDF, please use Merge Scan function.

 **Note:** • The Merge Scan allow the document to be scanned into the PDF format by default.  
• This printer can perform Merge Scan operation only on the control panel.

The specific operations are as follows:

1. Press "Scan" button to enter scan status. The default scan mode of control panel is Single Page.

### M6200/M6500/M6550 Series

### M6600 Series

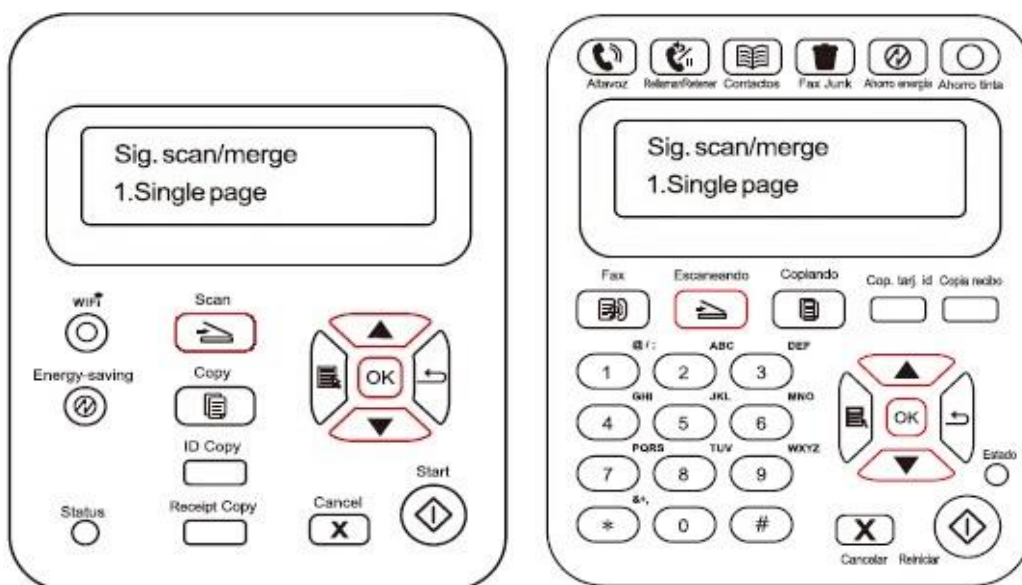

2. Press "▲" or "▼" button to select and enter "Merge Scan" mode.

**M6200/M6500/M6550 Series**

**M6600 Series**

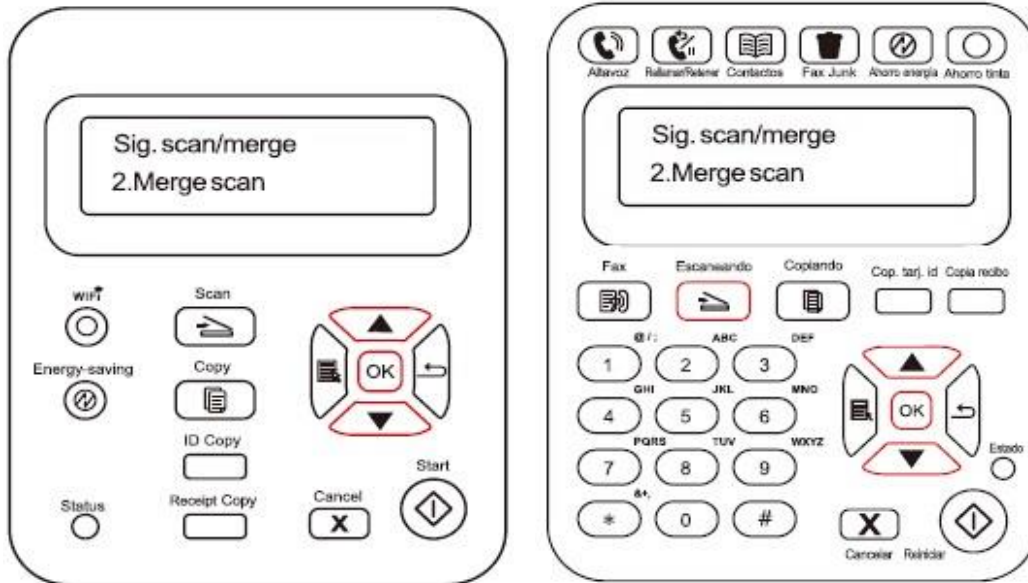

3. Press "Start" button and the Scan Process Bar Interface will pop up on the computer.

4. After completing scanning the first page, the contents as shown below will appear on the control panel:

Press "Start" button - scan the next page

Press "OK" button- end the scanning

5. Put the document to be scanned on the glass platen and press Start button to continue to scan the second page (For ADF scanning, it can run continuous scan directly).

6. Repeat the operation as described in the step 5 to scan multi-pages till you press "OK" button to end this operation.

7. After completing the operation, the application will save PDF document to the specified folder.

## 10.1.5. Other Scan Functions

### 1. Scan to E-mail

Users can scan monochrome or color documents as attachments to E-mail application. Operation steps as follows:

- ① Type the IP address in the Web browser's address bar to access the embedded Web server of the printer.
- ② Click on "Setting"—"SMTP" to set the relative parameters of the SMTP Protocol; After finishing setting, click on "Apply" to save.

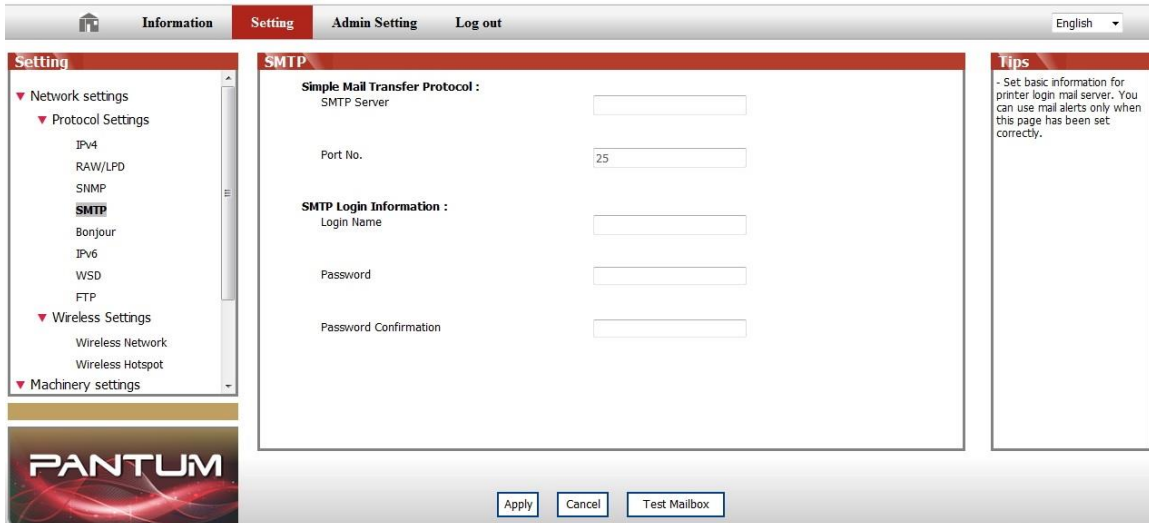

- ③ Click on "E-mail Address Book" in the left setting column to enter into the settings interface of the email.

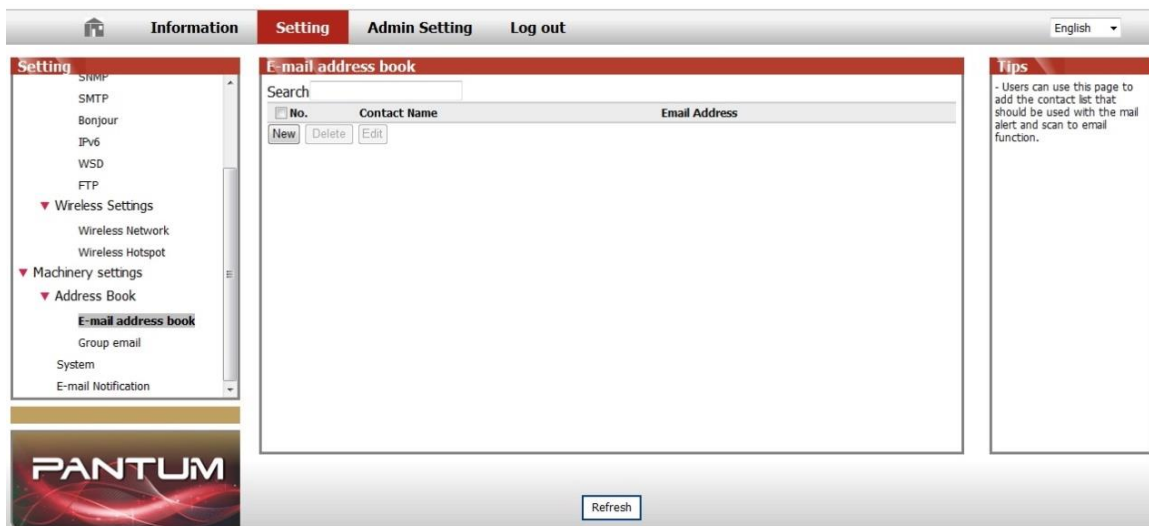

- ④ Click on "New" and the following window will pop up, edit the name of contacts, input the E-mail address and then click on "Submit".

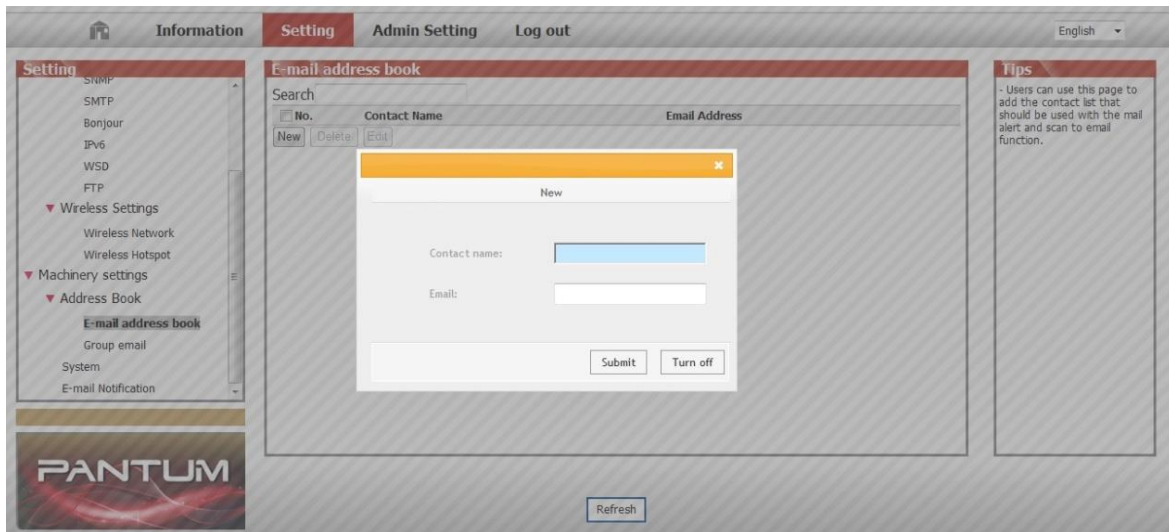

- ⑤ Put the document on the platen.

**M6200/M6500 Series**

**M6550/M6600 Series**

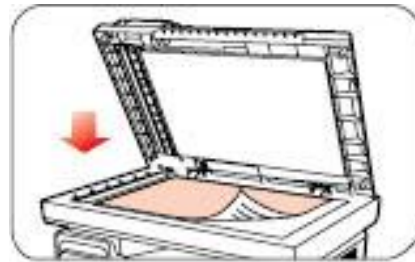
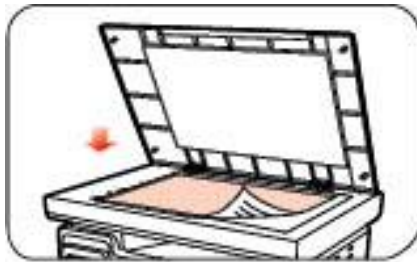

- ⑥ Press "Scan" button on the control panel, and press "▲" or "▼" to select "Single Page Scan" or "Merge Scan", then press "OK" button.
- ⑦ In the "Scan To" interface, press "OK" button.
- ⑧ Press "▲" or "▼" to select "Scan to E-mail" and press "OK" button.
- ⑨ Press "▲" or "▼" to select "E-mail Address Book" or "Group Mail" and press "OK" button.
- ⑩ Press "▲" or "▼" to select address or group and then press "OK" button; press "Start" button to start scan.

Please follow these instructions on the settings for group emails:

Set the group name for group e-mail sending by webpage, and set the members, i.e.the receivers, in the group of group email. After finishing scanning, firmware will send the scanned documents to the mail server. Then mail server sends the documents to every member of the group.



## 2. Scan to FTP

Scanning to FTP requires a network environment. Users can scan comparatively large files online. Users need to log in FTP server with user name and password and install IIS Component on the computer.

### 1) Operation Steps:

- ① Type the IP address in the Web browser's address bar to access the embedded Web server of the printer.
- ② Click on "Setting" – "FTP" to enter into FTP Setting interface.

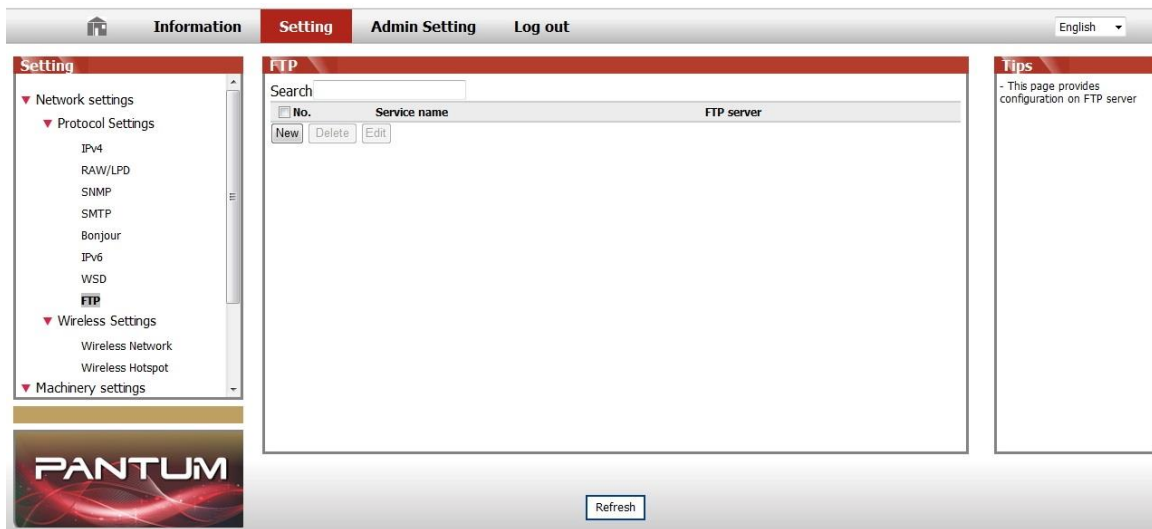

- ③ Click "New", the following window will pop up. Set the relative parameters of the FTP Protocol. After complete setting, click on "Submit".

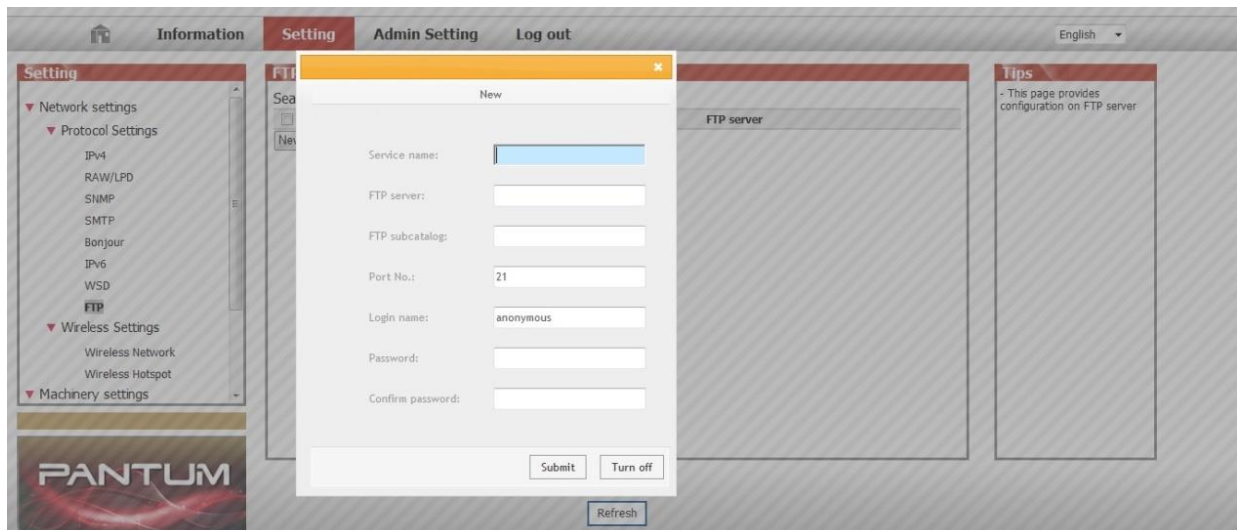

- ④ Put the document on the platen.

---

**M6200/M6500 Series**



**M6550/M6600 Series**

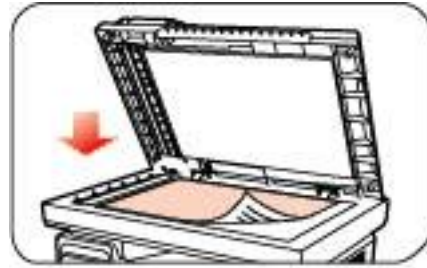

- 
- ⑤ Press "Scan" button on the control panel, press "▲" or "▼" to select "Single Page Scan" or "Merge Scan" and press "OK" button.
- ⑥ In the "Scan To" interface, press "OK" button.
- ⑦ Press "▲" or "▼" to select "Scan to FTP" and press "OK" button.
- ⑧ Press "▲" or "▼" to select the server and press "OK" button; Press "Start" button to start scan.

---

 **Note:** The relative parameters setting of the FTP Protocol are as follows:

FTP Server: IP Address of the server (such as 10.10.145.100 )

Port Number: Default port number is 21

Login Name: For example, anonymous

Password: such as (anonymous login needs no password)

Confirm Password: For example (anonymous login needs no password)

Server Name: For example, Pantum

---

## 10.2. Pull Scan

### 10.2.1. Pantum Scan Application

Operation Steps:

1. Double click on "Pantum Scan Application" on the computer, the icon is shown as below:



2. The prompt window is shown as below:

---

 **Note:** • This device supports FB combination scan. If you would like to combine the scanned documents, select "Combine scanned documents" on the interface below.  
• Combine scanned documents only works for save types of TIF/PDF/OFD.

---

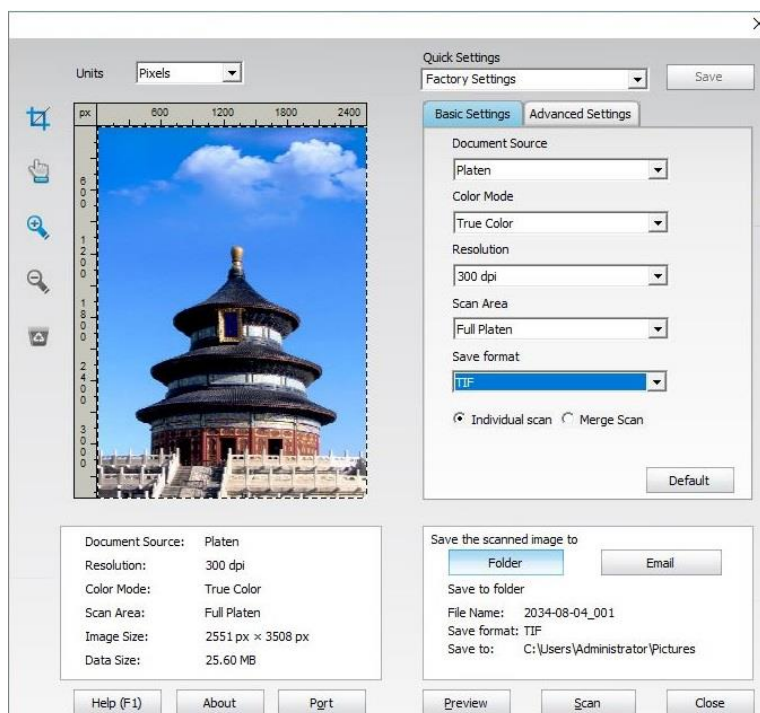

3. Set Scan in the right list. Click "Scan" on the bottom right corner and start scan.

---

 **Note:** • Images scanned by Pantum scanning application software support six file types: BMP, JPG, TIF, PDF, PNG and OFD.

---

This product complies with the TWAIN and Windows Image Application (WIA) standard. If using the application which supports TWAIN and WIA standard, users can use the scan function and directly scan the images to the open application. The handbook requires Office Software (Word and Excel) and Photoshop ,for example, to show the operation.

## 10.2.2. TWAIN Scan Driver

### 10.2.2.1. Office Software (Word and Excel)

Operation Steps:

1. Keyboard shortcuts: Alt+I+P+S to open the application's window.

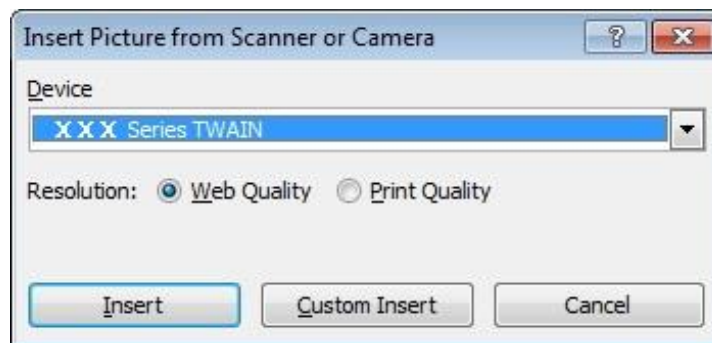

2. Click on "Device" option and select TWAIN Scan, click the "Custom Insert" button below.

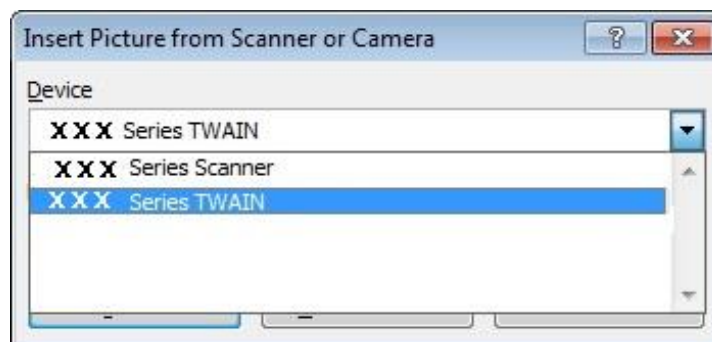

3. After the window pops up, set the scan information in the right list of "Basic Setting" and "Advanced Setting". Click on "Scan" and start scan.

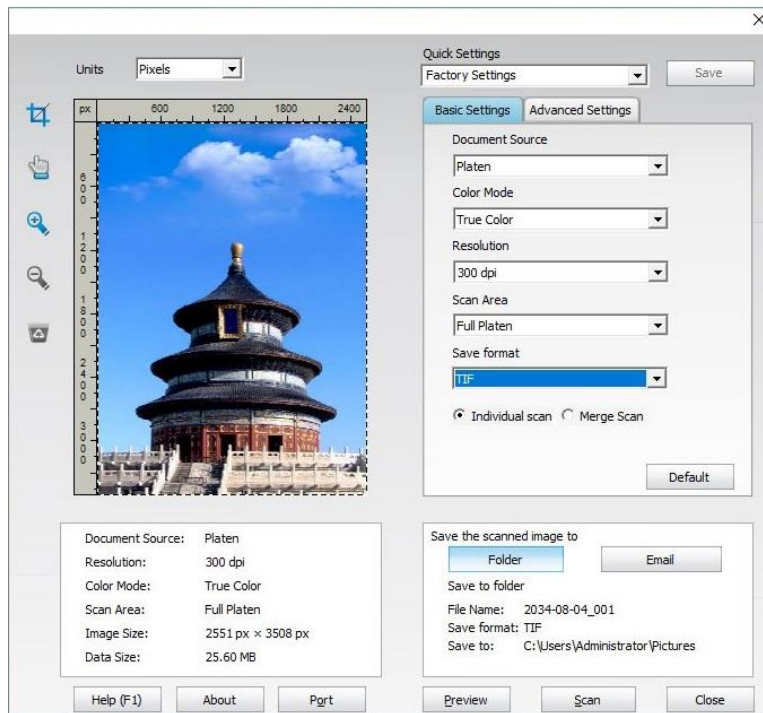

If you desire to change a scanning port, please click "Port" at the lower part of above picture to select a scanning port, as shown below:

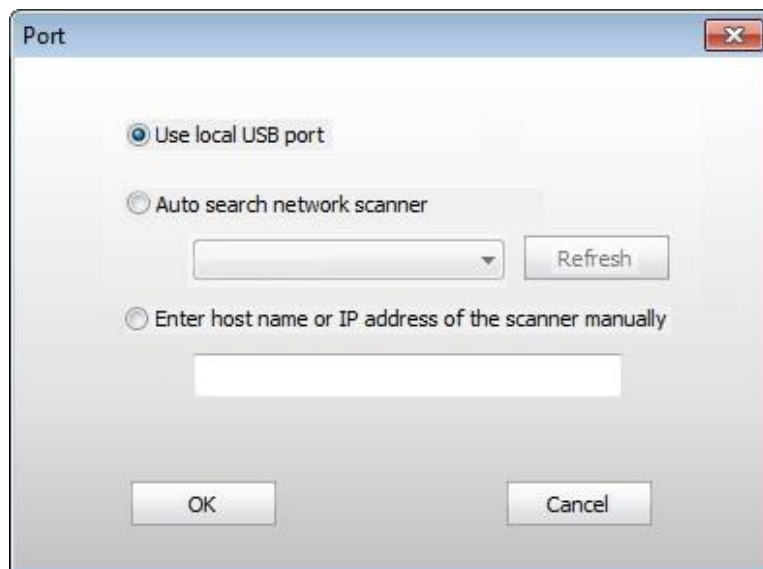

## 10.2.2.2. Photoshop

Operation Steps:

1. Launch Photoshop, click on "File" – "Import" on the top left corner, select TWAIN Scan, as is shown below:

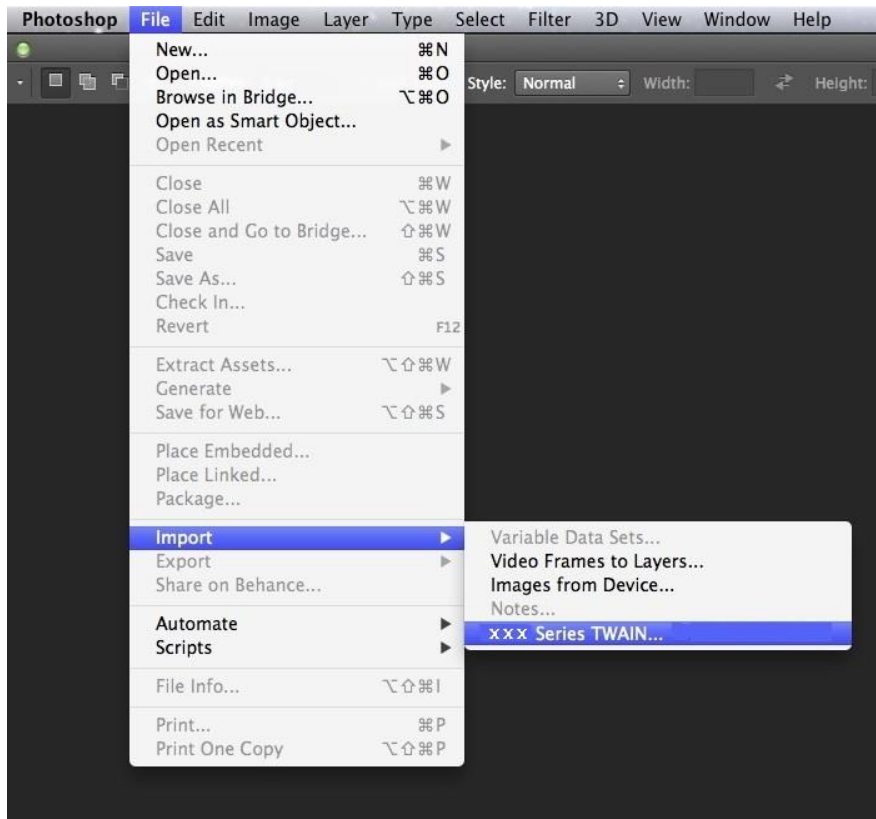

2. After the window pops up, please refer to Step 3 of [10.2.2.1](#) to see the specific operation steps.

## 10.2.3. WIA Scan Driver

### 10.2.3.1. WIA1.0 Scan (Windows XP)

1. Office Software (Word and Excel)

Operation Steps:

1) Keyboard shortcuts: Alt+I+P+S to open the application's window.

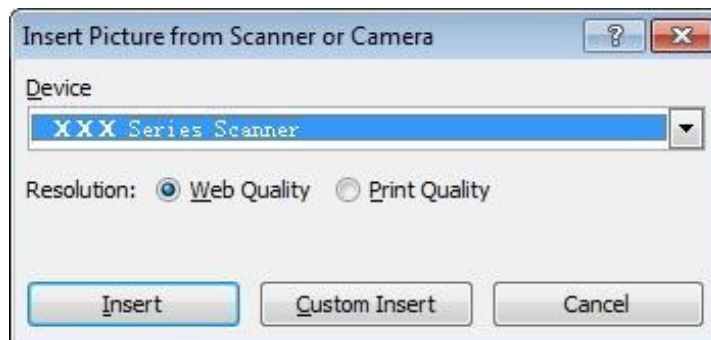

2) Click on "Device" and select WIA Scan,click the "Custom Insert" below.

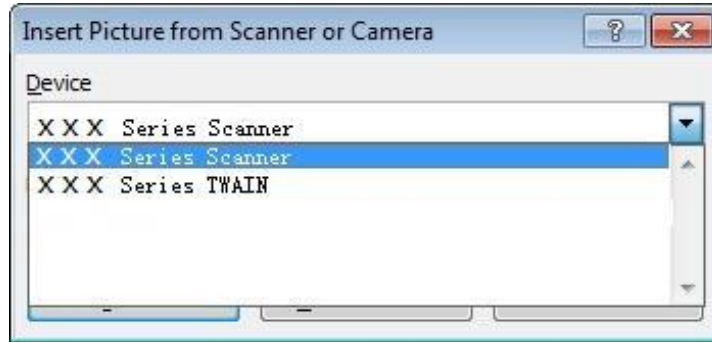

3) The prompt window as is shown below, set the scan information.

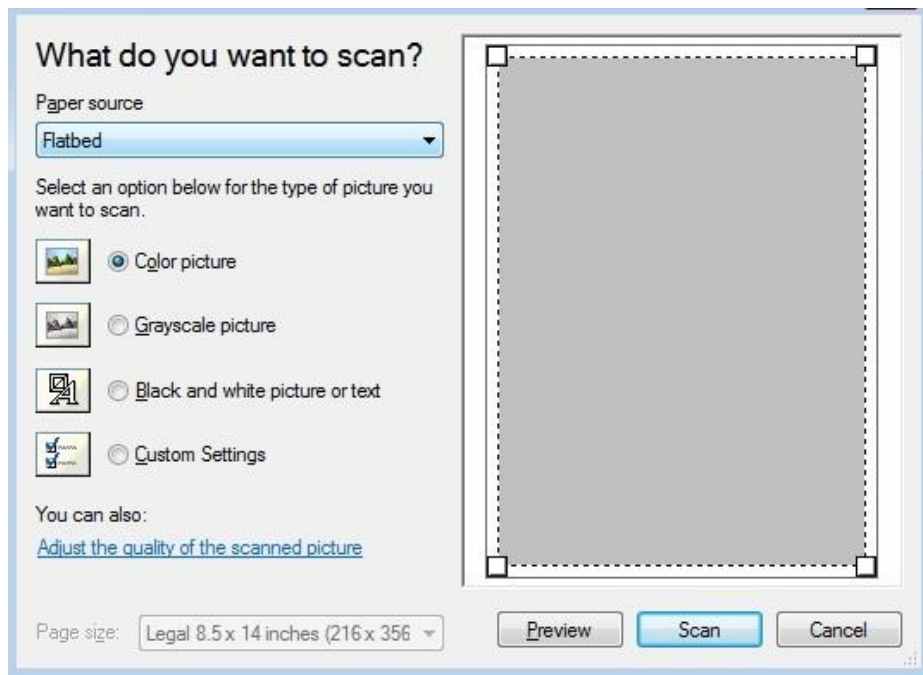

4) Click on "Adjust the Scanned Image Quality" on the bottom left corner of the above picture, the advanced properties interface will pop up, then users can set the scan; After finishing the settings, click on the "OK" button, then "Scan" button to start scan.

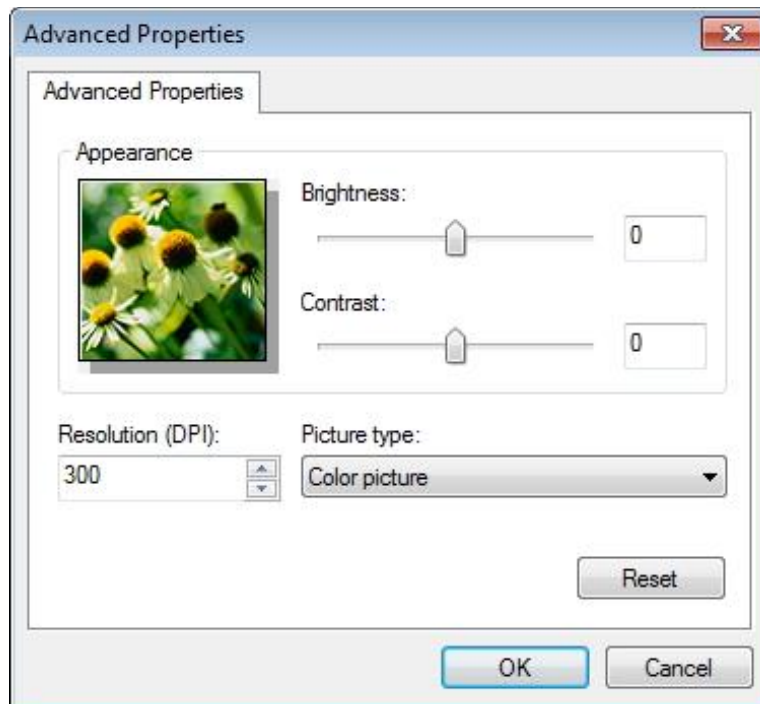

## 2. Photoshop

### Operation Steps:

1) Launch Photoshop, click "File"- "Import" on the top left conrner and select WIA Scan, as is shown below:

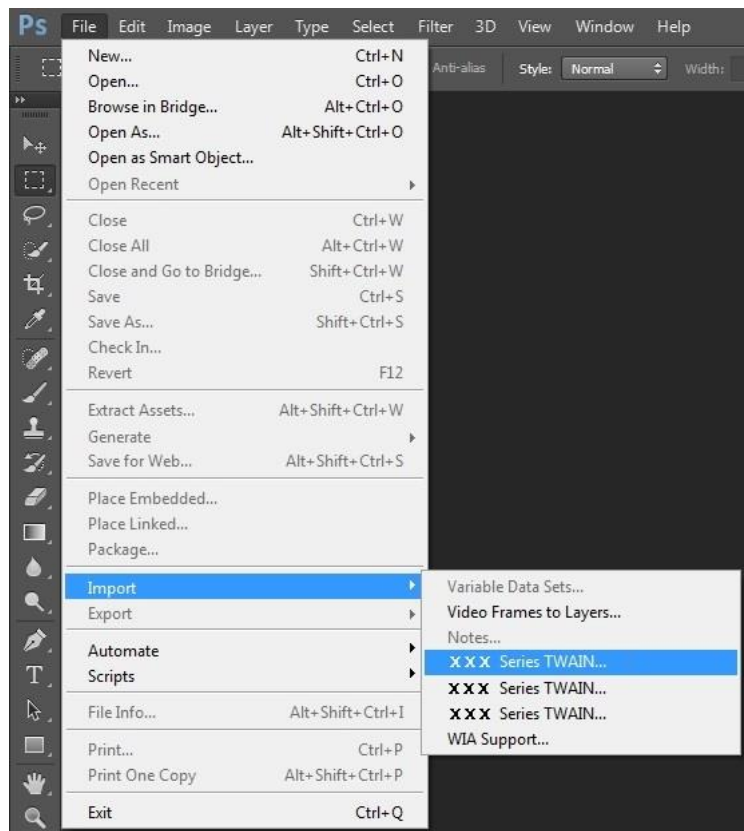



2) After the window pops up, please refer to Step 3 and Step 4 of [10.2.3.1](#) to see the specific operation steps.

### 10.2.3.2. WIA 2.0 Scan (Windows Vista / Windows Server 2008 and later versions)

Operation Steps:

1. Click on "Start"- "All Programs"- "Device and Printer" on the left bottom of the desktop.

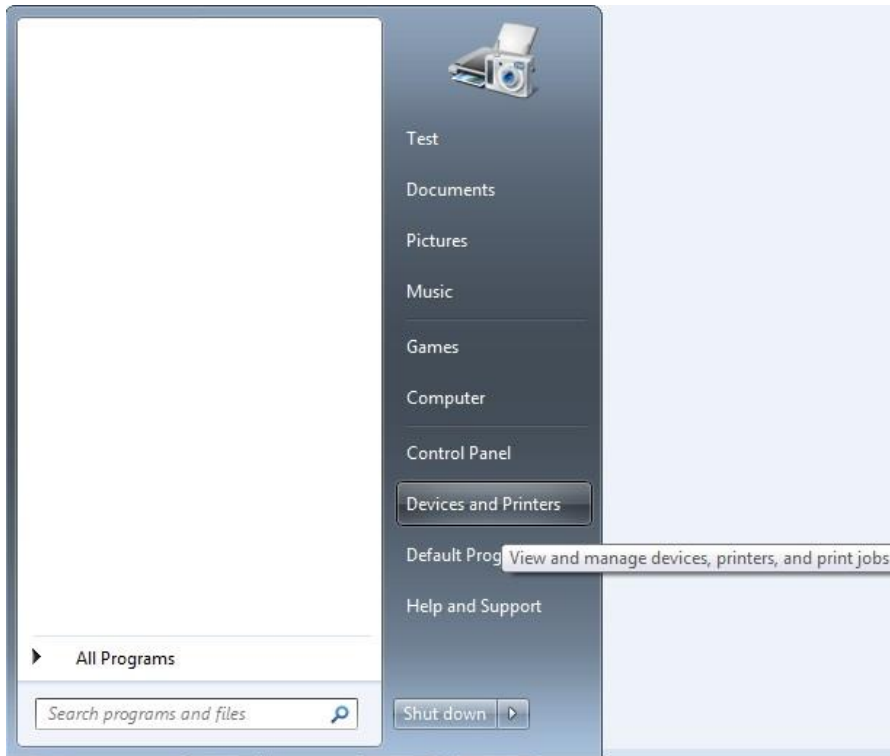

2. When the pop-up window appears, select the printer you want to use, and right click the mouse.

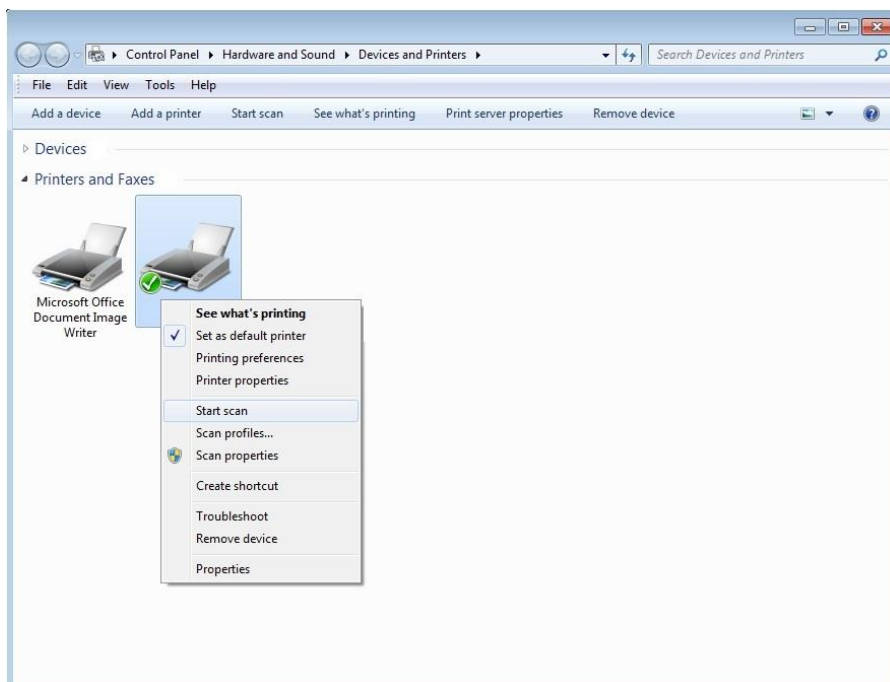

3. Click on "Start Scan" in the above option bar.

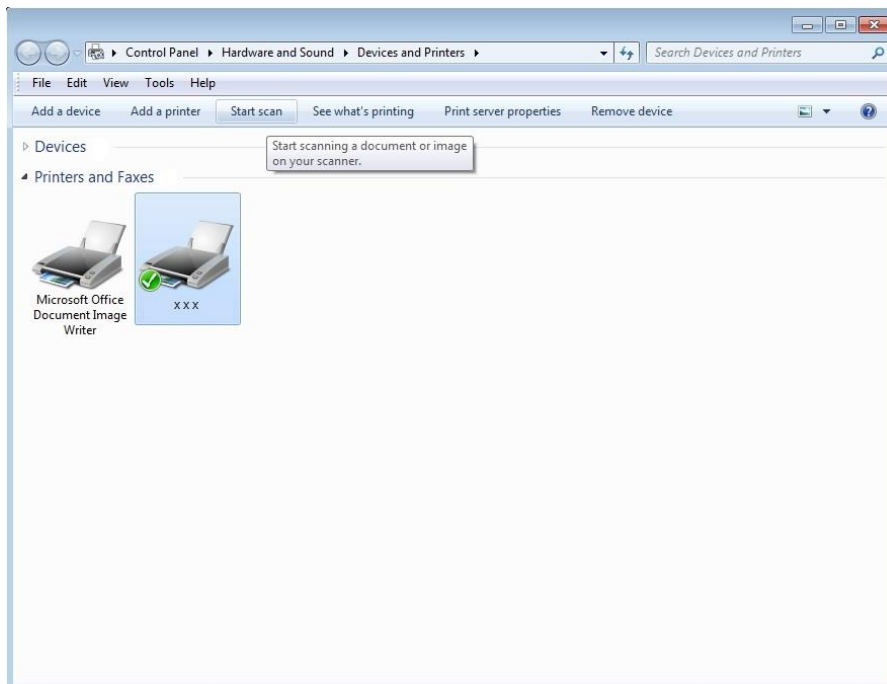

4. After the window pops up, set the scan and click "Scan" on the bottom right corner and start scan.

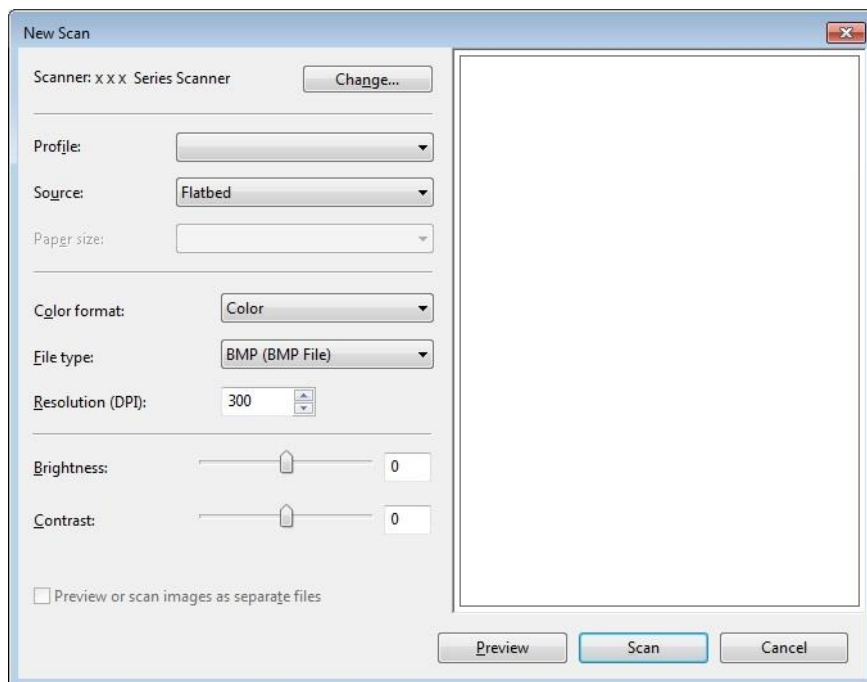

### 10.2.4. Cancel Scan Job

During the scanning, two ways are available to cancel the job:

1. Press "Cancel" button on the control panel to cancel the job.
2. Click Cancel button on the scan progress bar interface of the computer to cancel the job.

## 10.3. macOS System Scan

### 10.3.1. ICA Scan

#### 10.3.1.1. Open ICA via "Print and Scan"

Operation Steps:

1. After installing the printer driver, click "System Preferences" icon on the bottom left corner of the computer desktop.



2. After the window pops up, click on "Print and Scan".



3. After the window pops up, click on "Scan".

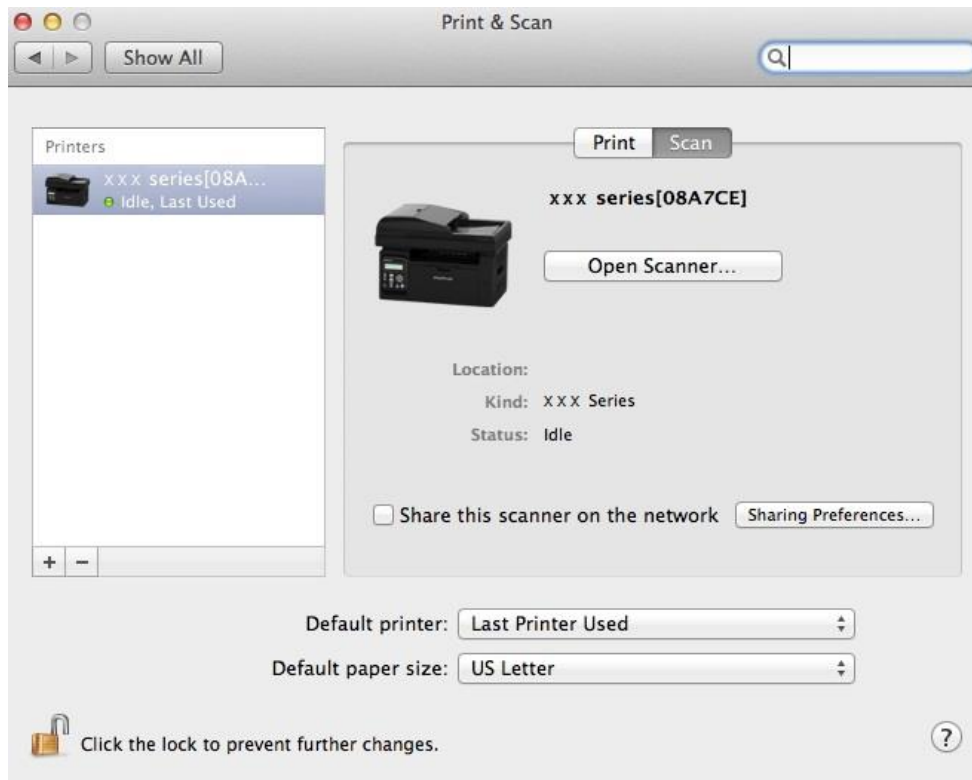

4. Click on "Open Scanner" and the scan window will pop up.

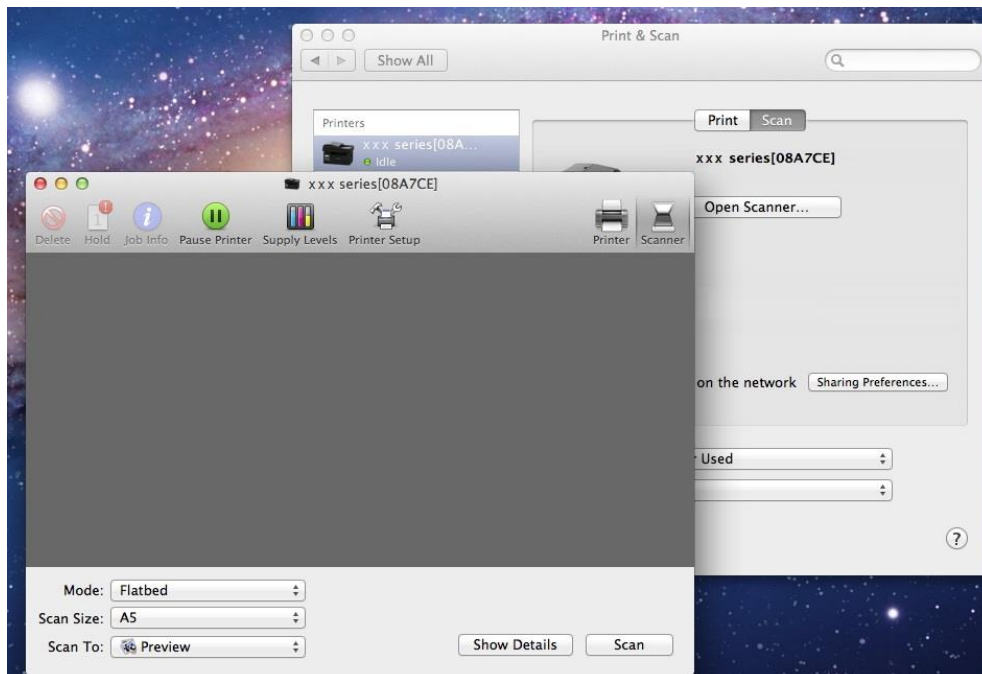

5. Click on "Show Details" on the bottom right corner to set the scan parameters.

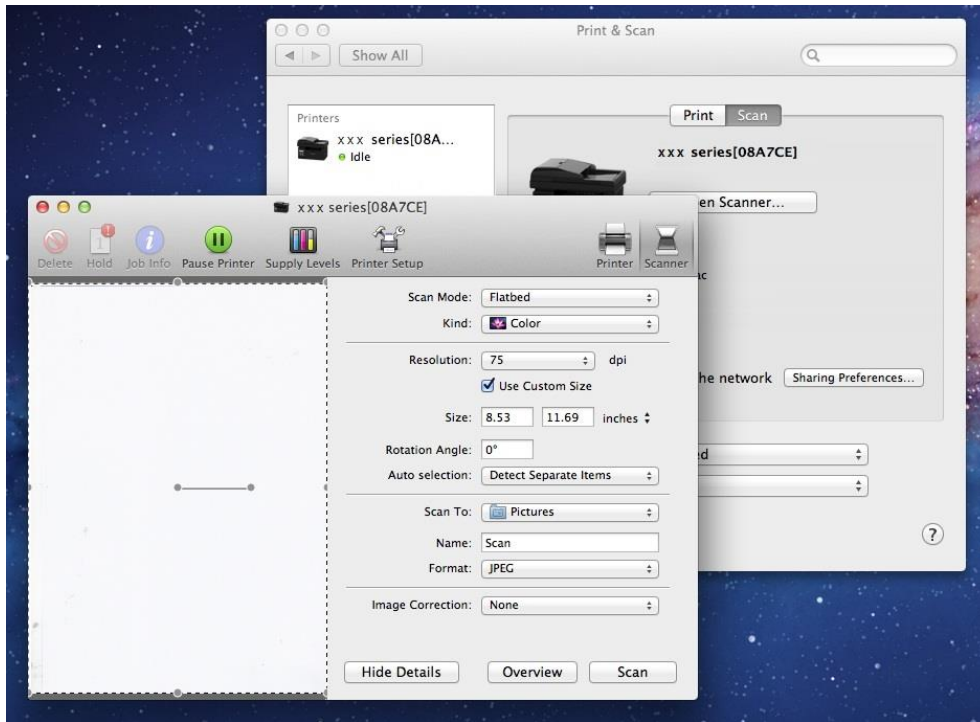

6. Click on "Scan" on the bottom right corner and start scan.

### 10.3.1.2. Call CIA through applications

Operation Steps:

1. Click on "Finder" icon on the bottom left corner of the computer desktop, or use keyboard shortcuts command+shift+C to open the window. Find "Image Capture" in "Applications" (or conduct keyboard shortcuts command+shift+A to directly switch to "Applications") and click to launch the application.

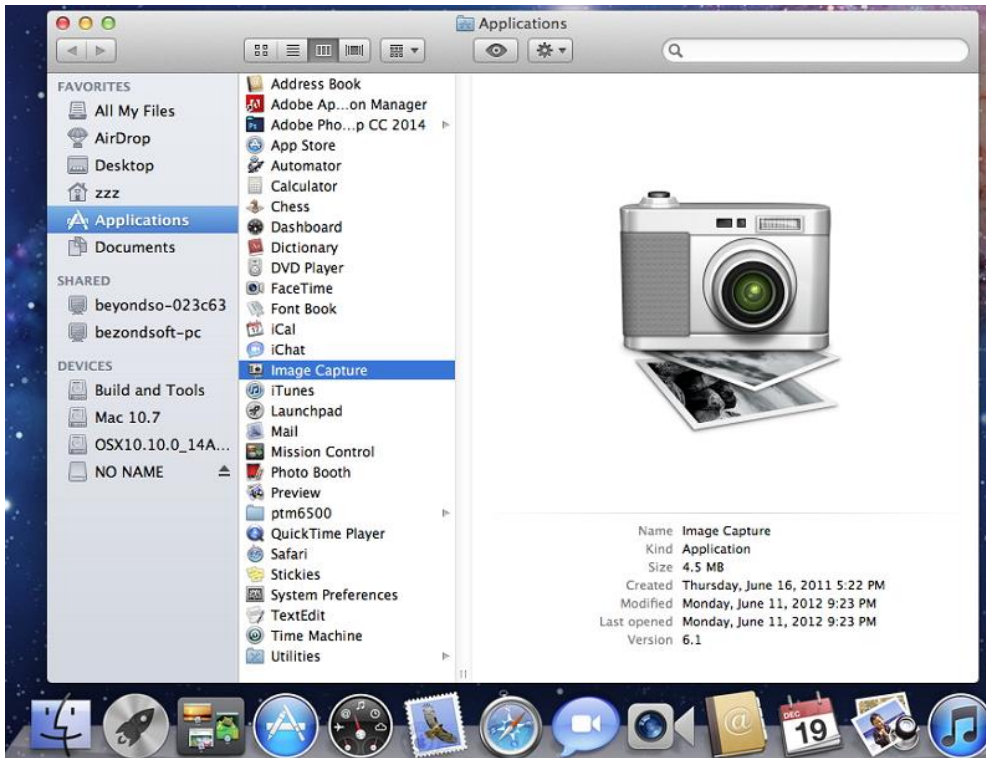

2. After selecting the printer in the left list, set the scan parameters in the right list. Click on "Scan" on the bottom right corner and start scan.

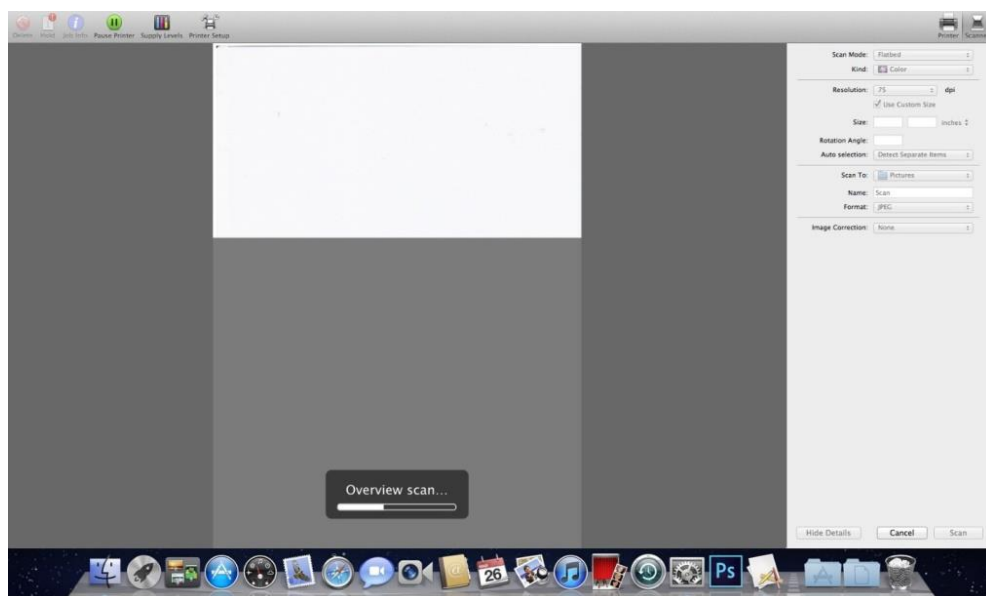

### 10.3.2. TWAIN Scan

Take Photoshop as an example.

Operation Steps:

1. Launch Photoshop, click on "File" – "Import" on the top left corner and select TWAIN Scan, as is shown below:

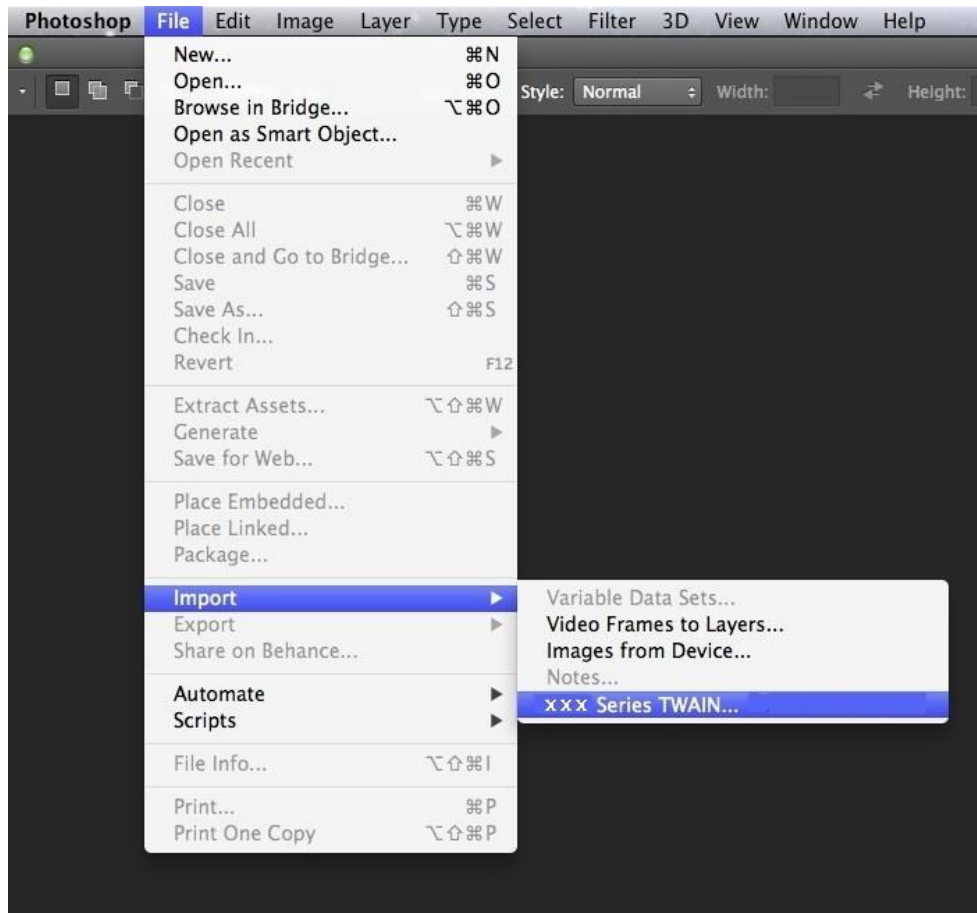

2. After the window pops up, please refer to Step 3 of [10.2.2.1](#) to see the specific operation steps.

# 11. Fax



## 11.1. Connect Devices

Connect the Fax accessories to the phone line

This product includes two Fax ports:

- Connect this product to the "  " port of the telephone jack on the wall.
- Connect the auxiliary devices to the "  " port of this product.

The installation steps are as follows:

1. Unplug the power cords of all the devices you want to connect.
2. If this product has not been connected to the phone line, see the product installation guide. The product should have been connected to the telephone jack.
3. Remove the plastic plug of the "  " port.
4. To connect the included phone handle, plug the phone cord into the printer&apos;s "  " port. Conne<sup>c</sup> the other end of the phone cord to the phone handle.
5. To connect the telephone device alone, plug the phone cord into the printer&apos;s "  " port.

Plug the other end of the phone cord to the telephone's "  " port.

6. When you are finished with connecting auxiliary devices, connect all devices to their power supply.

## 11.2. Fax Settings

This product supports two ways to make the Fax settings for users&apos; different Fax requirements.

**One way is to complete the Fax settings under the Fax Mode, and the steps are as follows:**

1. When the machine is ready, press Fax button, then press OK button to enter the Fax settings interface.

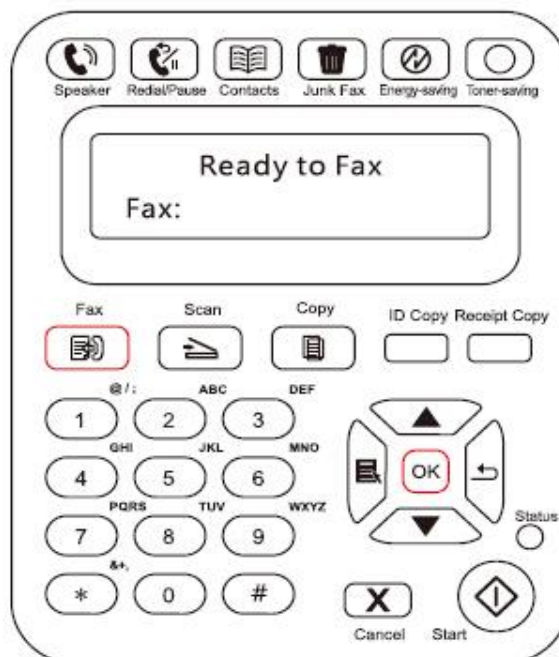



2. Choose the Fax option you want to set by pressing the page up and down keys.

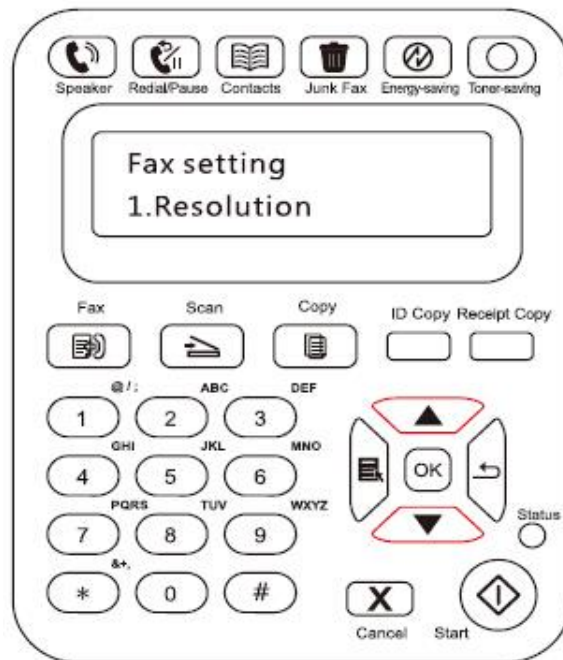

3. Nine settings are available here. The following is the instruction on these settings:

No.	Options	Description
1	Resolution	You can select the image quality of the Fax. The available options are Normal, Fine and Super fine, and the default is Normal.
2	Original Size	You can select the desired size of the document to be Faxed. The available options are A4, Letter and Legal.
3	Luminosity	You can adjust the luminosity of Fax documents manually or automatically.
4	Group Sending	You can enter each Fax number you want to send Fax to through group sending and the maximum for group sending is 10 Fax numbers.
5	Delay Sending	With Delay Sending, you can set the Fax number and time (within 24 hours) for Delay sending to send the Fax job on the time you set.
6	Forward the Received	Forward the Received option has two suboptions. If you select the Forward to Fax suboption and enter the number to which you want to forward the Fax, the printer will send the Fax to the forwarded number rather than printing it when you receive a Fax; With the Forward to Fax enabled, if you select Forward and Print, the printer will print the Fax and also forward it to the forwarded number when you receive a Fax.
7	Active Job	Query for the list of all Faxes for Delay sending and you can press the Cancel button to delete a Delay sending job.
8	Communication record	Inquire the latest 30 times of Fax sending/ receiving.

You can edit the contacts, group numbers, and print the contacts as well as the list of group numbers from Contacts.

### Another way is to specify the Fax Settings in the Menu Settings

1. When the machine is ready, press the menu button and press the up button "▲" or the down button "▼" to select Fax settings;

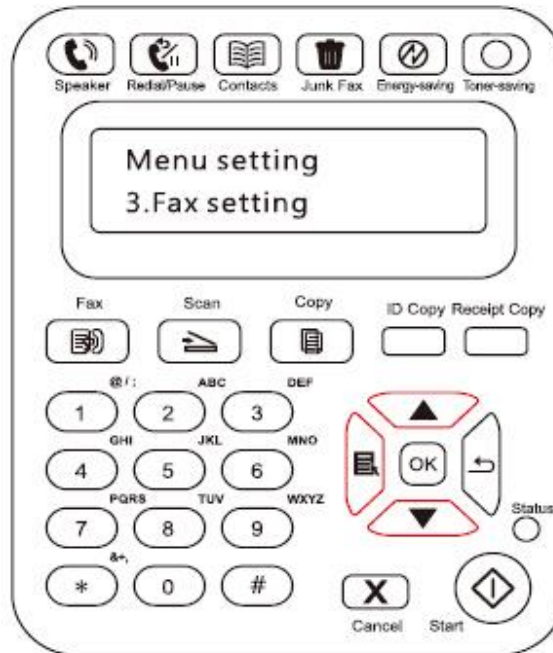

2. Press the OK button to enter the Fax setting options and press the up button "▲" or the down button "▼" to enter the Fax settings.

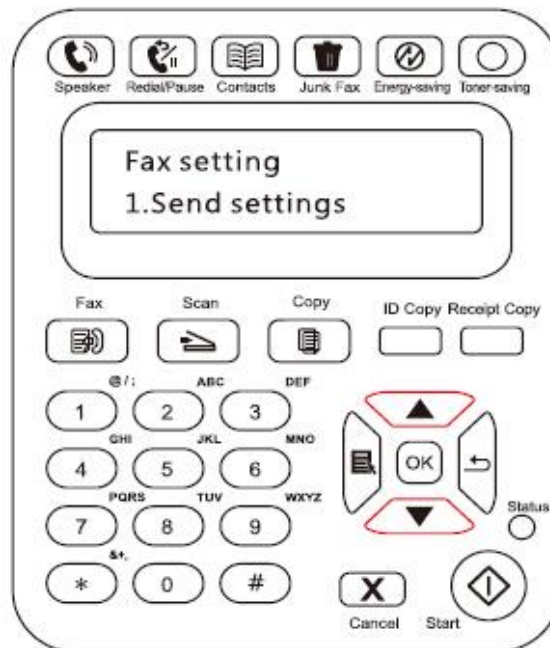

3. Three categories of Fax setting options are available here. The following is the instruction on these settings:

No.	Options	Description
1	Send Settings	You can use the options in Send Settings to set the parameters for sending Fax.
2	Receive Settings	You can use the options in Receive Settings to set the parameters for receiving Fax.
3	Compatibility	If Fax is sent or received abnormally due to disturbance on telephone line, try to switch to VOIP compatibility mode.
4	National area	Set different national areas based on demand.
5	Fax Report	You can use the options in Fax Report to print the Fax report as you need.

## 11.3. Fax Functions

### 11.3.1. Send Fax

Send a Fax from a flatbed scanner

1. Put the document face down on the scanner's glass platen and close the scanner.

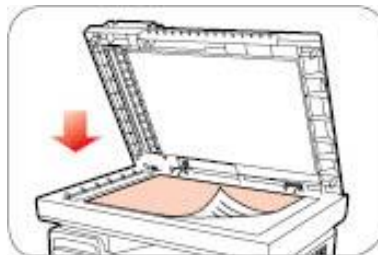

2. Press the Fax button and use the number buttons to enter the Fax number.

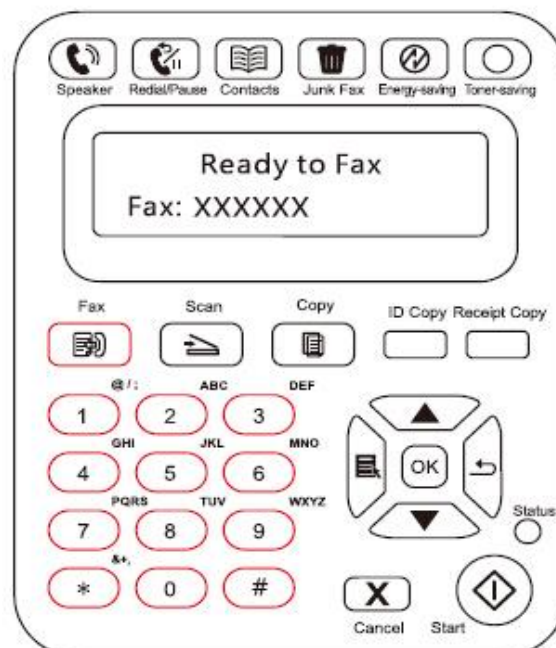

3. Press the Start button to start scanning the document.

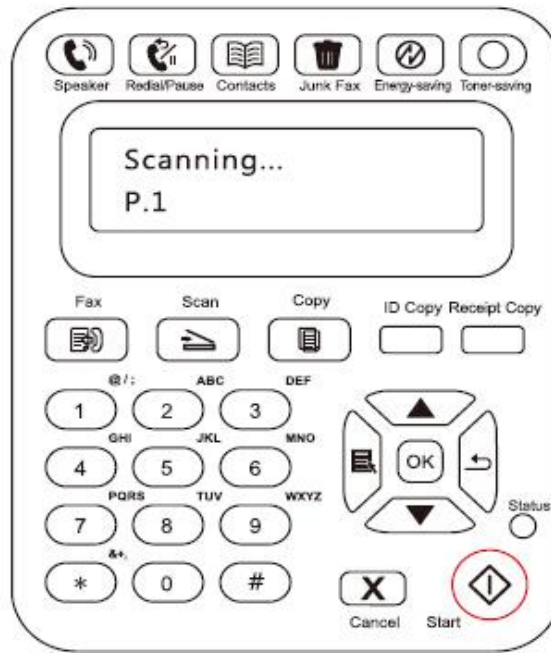

4. Press the OK button to initiate the Fax job.



## Send a Fax from the automatic document feeder (ADF)

1. Put the document face up into the automatic document feeder.



- 
-  **Note:** • Automatic document feeder can accommodate up to 35 sheets of medium measuring 75 g/m<sup>2</sup> or 20 pounds.
- In order to prevent damage to this product, do not use a manuscript with correction tape, correction fluid, paper clips or staples on it. In addition, do not load photos, small manuscripts or brittle manuscripts into the automatic document feeder.
- 

2. Adjust the guide plate until it lies close to the stack of paper.
3. Press the Fax button and use the number buttons to enter the Fax number.



4. Press the Start button to start scanning the document with the automatic document feeder.

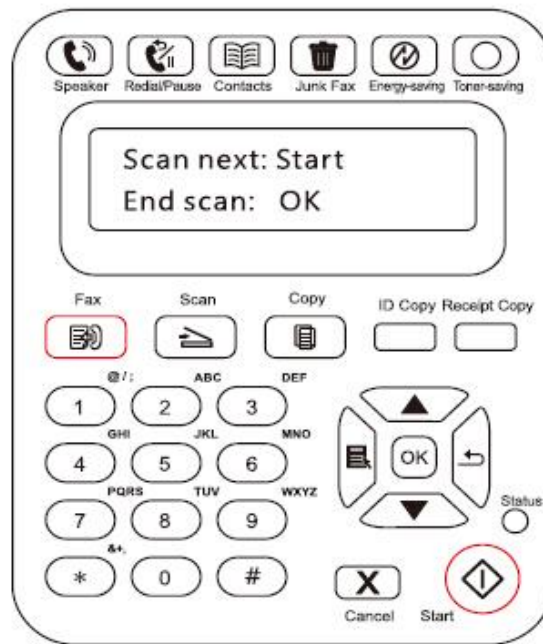

### 11.3.2. Receive Fax

You have two ways to receive Fax, and the default for the printer is Fax mode.

Fax mode, which is the automatic receiving mode, sends Faxes to the printer, and the printer receives the Fax automatically when the ring reaches the specified number of times;

Phone mode, which is the manual receiving mode, sends Faxes to the printer, and you need to receive the Fax manually when the ring prompts.

#### 11.3.2.1 Fax Mode

Operation Steps:

1. Press Menu button to enter the menu interface.
2. Press direction pad "▲" or "▼" to select "Fax Settings" option and press "OK" button.
3. Press direction pad "▲" or "▼" to select "Receive Settings" option and press "OK" button.
4. Press direction pad "▲" or "▼" to select "Answer Mode" option and press "OK" button.
5. Press direction pad "▲" or "▼" to select "Fax Mode" option and press "OK" button.
6. Go back to the previous menu, press direction pad "▲" or "▼" to select "Number of Rings" option and press "OK" button to set the number of rings. Then the printer will receive the Fax automatically when the ring reaches the specified number of times, and the default is 4 times.

#### 11.3.2.2 Phone Mode

Operation Steps:

1. Press Menu button to enter the menu interface.
2. Press direction pad "▲" or "▼" to select "Fax Settings" and press "OK" button.
3. Press direction pad "▲" or "▼" to select "Receive Settings" and press "OK" button.
4. Press direction pad "▲" or "▼" to select "Answer Mode" option and press "OK" button.
5. Press direction pad "▲" or "▼" to select "Phone Mode" option and press "OK" button.

In the phone mode, you have 3 ways to receive a Fax:

- 1) Press the Start button on the Control Panel and the machine starts to receive the Fax;
- 2) Take the phone handle or press the Speaker button on the Control Panel and press the Start button for the machine to start receiving the Fax;
- 3) Use the remote receiving mode (applies only to external telephone operations) to press "\*90" on the extension panel when the phone is taken and the machine starts to receive the Fax;

---

 **Note:** • To use the remote receiving mode, please set the remote code to Turn On.  
• The default for remote code is "\*90". You can modify it by the path "Menu"——"Fax Settings"——"Receive Settings"——"Remote Code"——"Turn On"——edit.

---

### 11.3.3. Other Scan Functions

#### Group Sending

You can use this product to send a Fax message to multiple Fax numbers and the maximum for group sending is 10 Fax numbers. The operations are as follows:

1. On the Control Panel, click on the Fax button to enter the Fax mode.
2. Press the OK button to enter the Fax Settings interface, and press "▲" or "▼" button to select Group Sending.

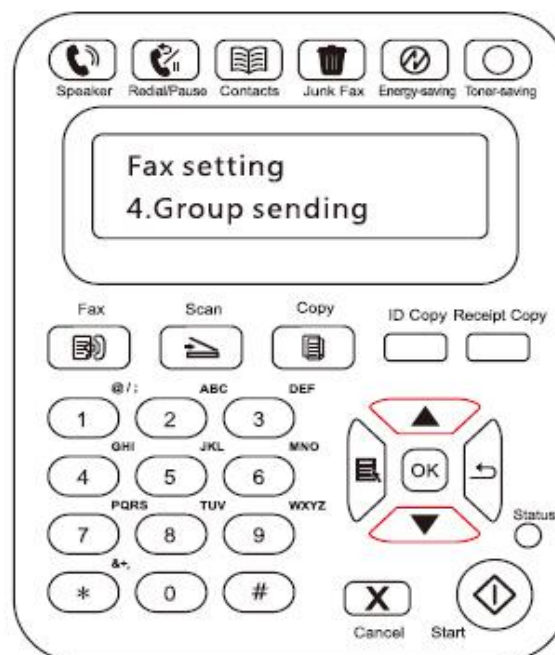

3. You can press the OK button and enter each Fax number to which you want to send Fax.

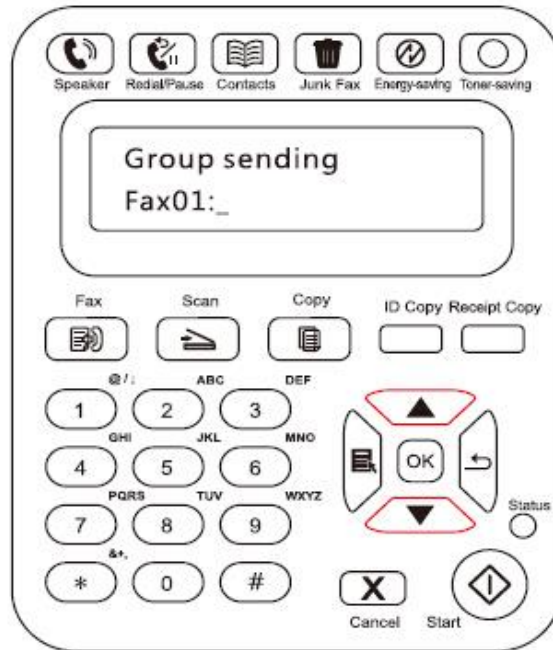

4. When the input is complete, press the Start button to start scanning documents.





5. When the scan is complete, press the OK button to begin the group sending Fax job.

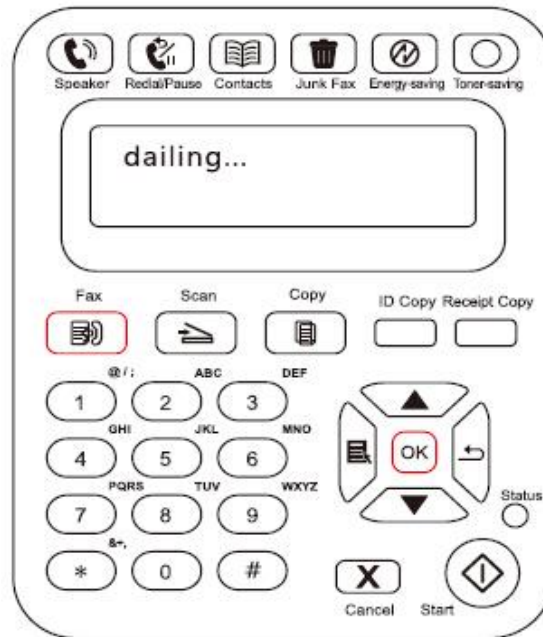

### Delay Sending

You can enable Delay sending of Fax through the Control Panel. When this process is complete, the printer will scan the document to the memory, and get back to Ready state.

The specific operations are as follows:

1. On the Control Panel, click on the Fax button to enter the Fax mode.
2. Press the OK button to enter the Fax Settings interface, and press "▲" or "▼" button to select Delay Sending

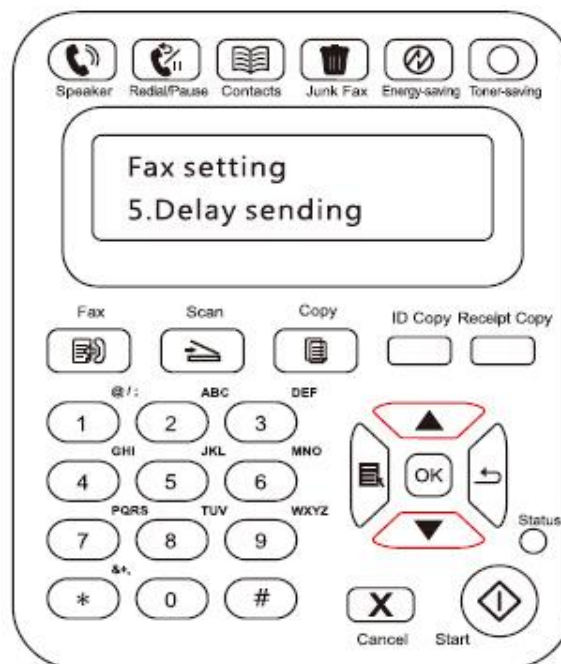

3. Set the Fax number, job name, and delay period as prompted.

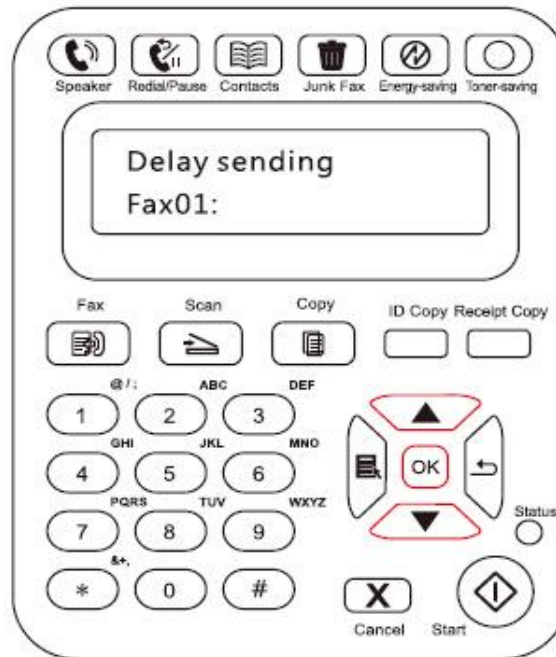

4. When the input is complete, press the OK button to scan the Fax document to the memory and get back to Ready state.

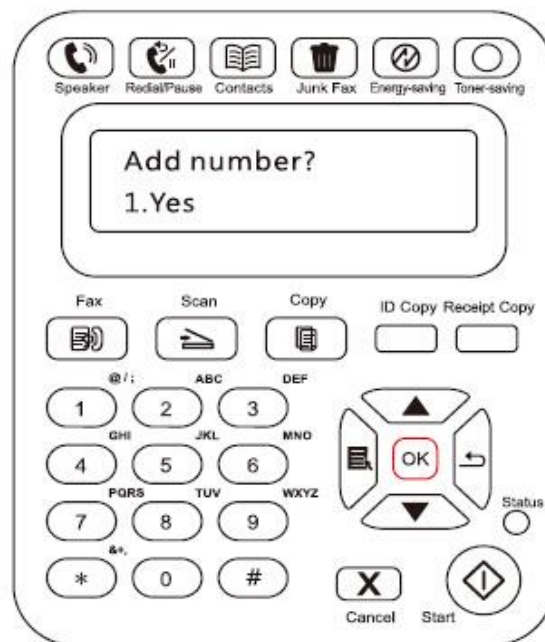

### Fax Forwarding

You can forward the Fax you receive. When you receive a Fax job, it will be stored in memory at first. Then the printer dials the Fax number you have specified and send the Fax. If the printer cannot forward a Fax because of an error (for example, the number is busy) and fails with repeated redial attempts, the printer will print the Fax.

**The Fax Forwarding feature of this printer is available in two modes:**

One mode is Forward to Fax: When you receive a Fax, the printer will send the Fax to the specified Fax number rather than printing it.

The other mode is Forward and Print: With the Forward to Fax enabled, if you enable Forward and Print when you receive a Fax, the printer will print the Fax and also forward one copy of the Fax to the forwarded number you have set.

The specific operations are as follows:

1. On the Control Panel, click on the Fax button to enter the Fax mode.
2. Press the OK button to enter the Fax Settings interface, and press "▲" or "▼" button to select Forward the Received

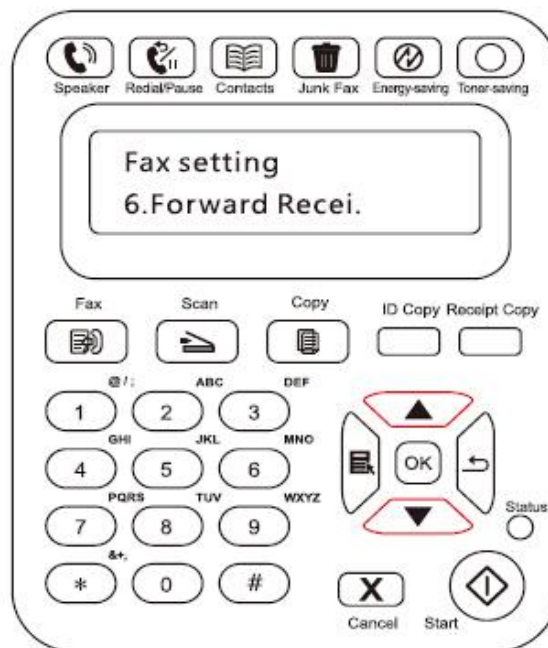

3. Set the forwarding mode and the number as prompted.

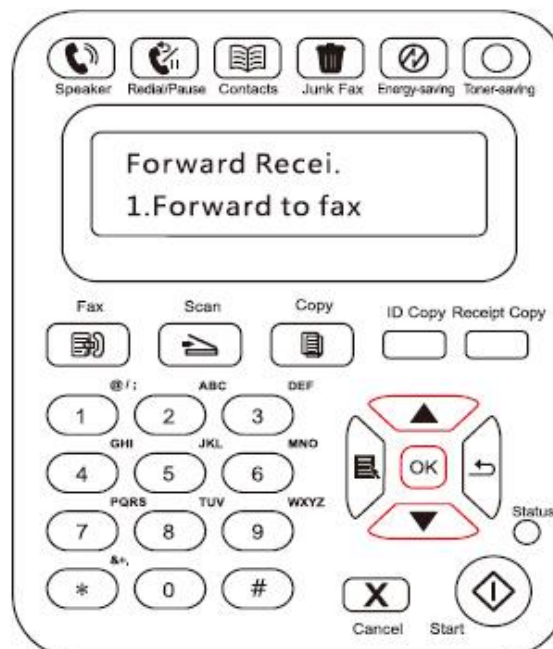

4. When the input is complete, press the OK button and the received Fax will be automatically forwarded to the specified Fax number.

### Automatic Redial

If the number you have dialed is busy or is not responding when you send a Fax, the machine will automatically redial the number. You can set the redial attempts and interval. The specific operations are as follows:

1. On the Control Panel, press Menu > Fax Settings > Send Settings.
2. Set the redial attempts and interval as you want.

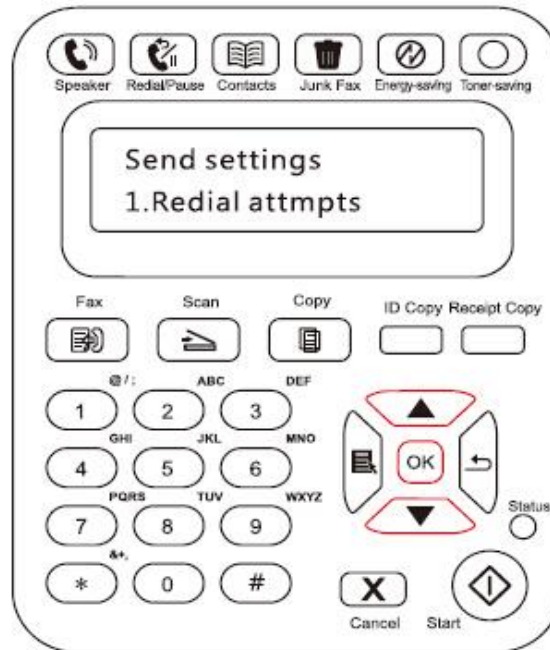

3. When you complete the setup, press the OK button to save the settings.

### Auto Shrink

When the paper size of the received Fax does not match the size specified in the printer, the received Fax will be shrunk according to the user-defined paper size to match the paper size in the printer.

If you disable the Auto Shrink option, the Fax will be printed at full size across multiple pages. Auto Shrink is turned on by default.

---

 **Note:** • Make sure that the default paper size setting is consistent with the size of the medium loaded in the paper tray.

---

### Auto Shrink operations are as follows:

1. On the Control Panel, press Menu > Fax Settings > Receive Settings > Auto Shrink.
2. Set it to Turn On or Turn Off the auto shrink function and set the shrink size.

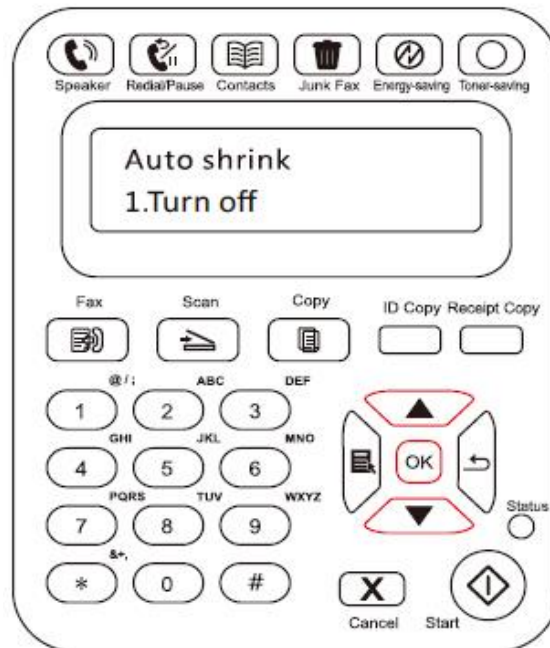

3. When you complete the setup, press the OK button to save the settings.

---

 **Note:** • Receive to Memory: When the machine runs out of paper or there is a paper jam, it automatically stores all the Faxes that is being received to the memory. It will automatically print the Faxes when the paper jam is resolved or the paper is loaded.

---

## 11.4. Contacts

You can edit the Contacts to edit the speed dial number and the group dial number so that you can use speed dial when you send a Fax.

### Speed Dial Number

In the Fax interface, press the Contacts button to enter the speed dial interface, enter the speed dial number, and the system will automatically search for it. If the speed dial number exists, the corresponding information is displayed, then press the Start button to begin the Faxing; If the speed dial number does not exist, an error message is displayed; You can store 200 speed dial numbers at the maximum.

### Group Dial Number

In the Fax interface, press the OK button to enter the Fax parameter settings interface, select Contacts to enter the Contacts interface, select the group dial to enter the group dial interface, select one of the groups, and press the Start button to begin group Faxing. You can set a maximum of 10 groups for Group Dial with up to 99 numbers in each group.

### Delete Contacts

You can delete all the Contacts you edited in the printer.

 **Note:** • Contacts cannot be restored once it has been deleted.

## 11.5. Cancel Fax

Please cancel Fax work with activity operation menu based on procedures below:

1. Press “OK” key in Fax interface.
2. Use direction key “▲” or “▼” to select activity operation menu and then press OK key.
3. Use direction key “▲” or “▼” to check work to be handled and then press OK key to select work canceled.
4. Press OK key to confirm work to be cancelled.

## 11.6. Pantum PC-Fax Software

Pantum PC-Fax function allows you to send a document from your computer as a Fax.

### 11.6.1. Open With

1. Open a Fax file that you want to send
2. Click File, click Print and the Print dialog pops up.

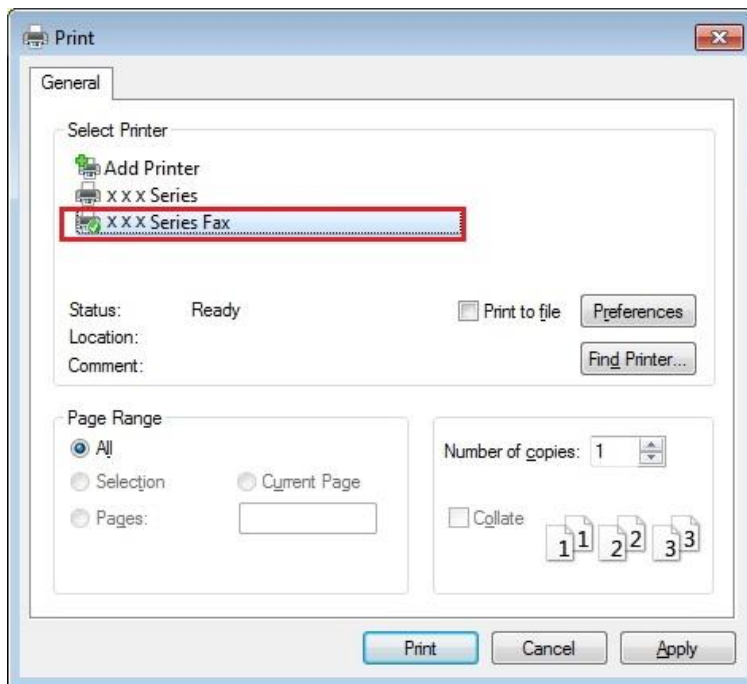

3. Select Pantum M6600NW Series Fax as the printer, click Print and the "Pantum will send Fax" interface appears.

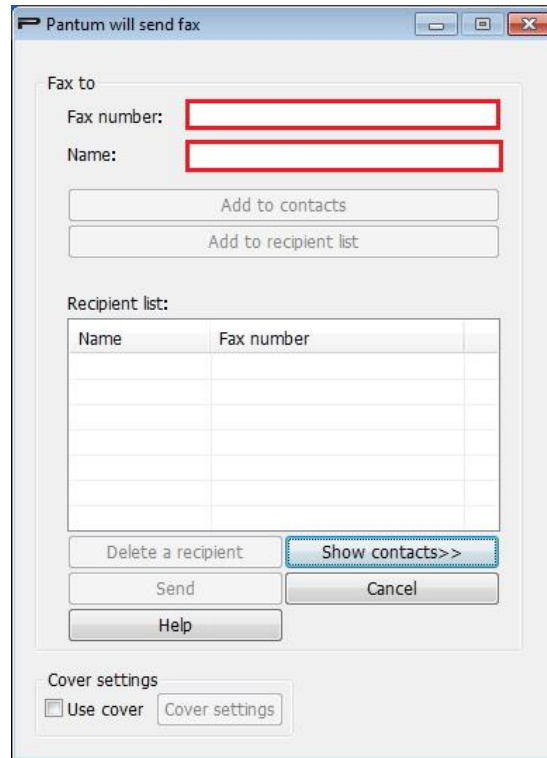

### 11.6.2. Sending Fax with PC-Fax

The operation steps for sending Fax with PC-Fax are as follows:

1. Open the PC-Fax software and the "Pantum will send Fax" interface appears.
2. Enter the Name and Fax Number, then click Add to recipient list; If you want to send the Fax to multiple addresses, you can continue to enter their Name and Fax Number, then click Add to recipient list.

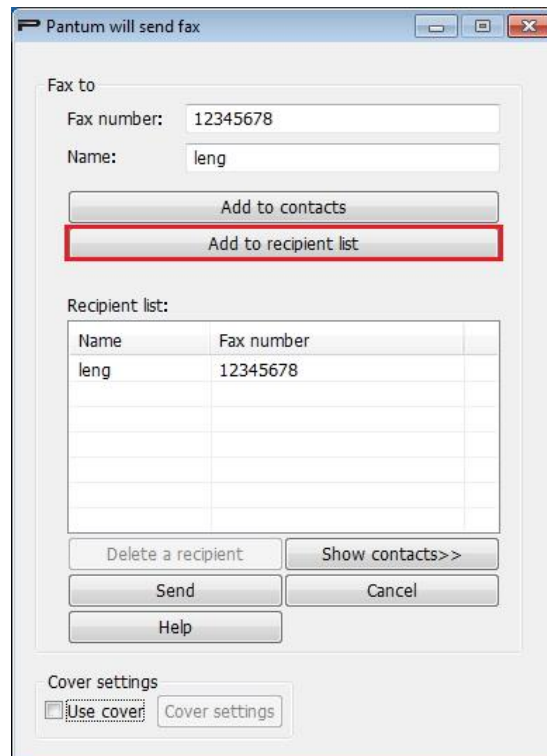

3. Click Send to start sending the Fax.

### 11.6.3. Basic Settings for PC-Fax

You can use the Fax Settings to set the Paper and Quality of the Fax that is sent with the PC-Fax. The specific operations are as follows

1. Open the PC-Fax software.
2. Select Pantum M6600NW Series Fax as the printer, click Printing Preferences and the Fax Settings interface appears.

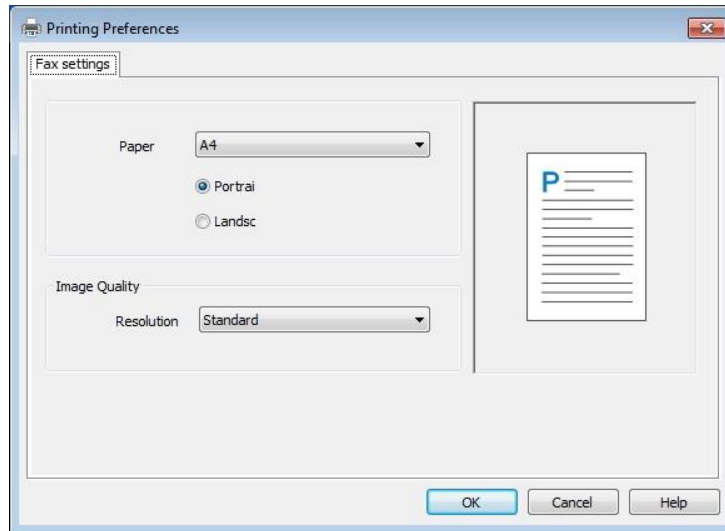

3. Select the Paper, Orientation and Resolution as you want.

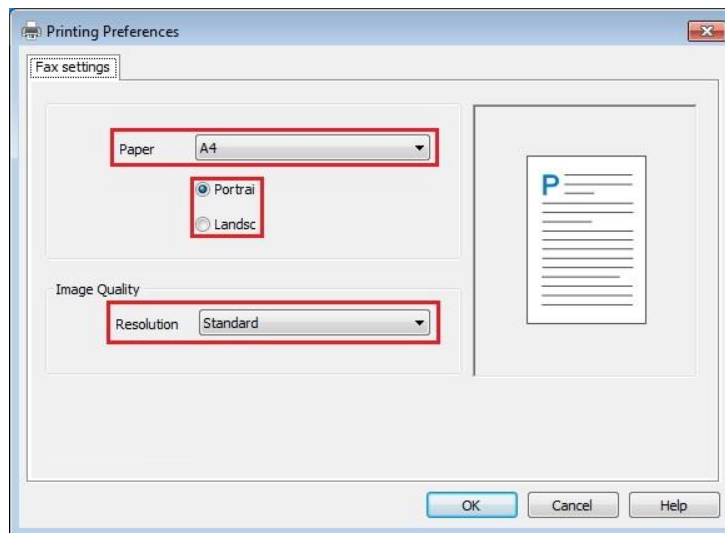

4. When you finish the selection, click OK to save the settings.



## 11.6.4. Other Functions for Sending Fax with PC-Fax

Use the Send Fax Settings to edit the local Contacts on M6600 Series and set the Fax cover page. The specific operations are as follows:

### Edit the Contacts in PC-Fax

1. Open the PC-Fax software and the "Pantum will send Fax" interface appears.
2. Click Show Contacts and the Contacts interface pops up on the right. Click Read to read the local Contacts list on the printer.

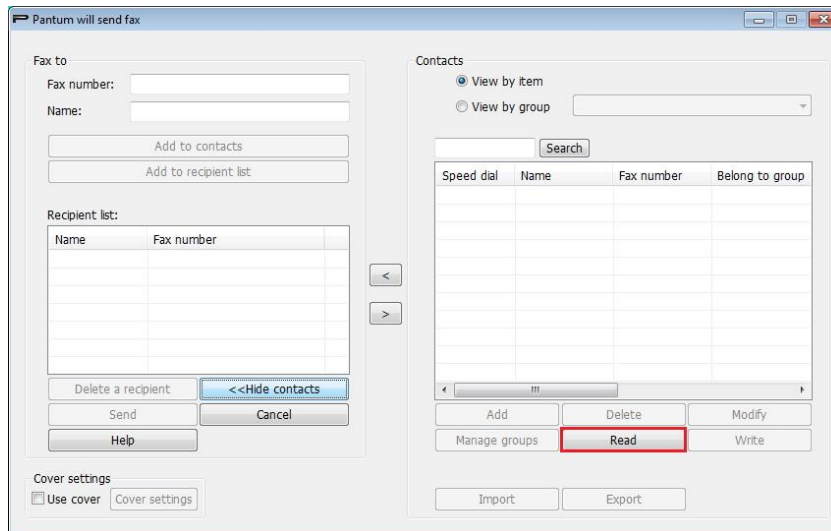

3. You can perform operations on the information in Contacts, including Add, Delete, Modify, Manage Groups, Import and Export.
4. Click Write to update the Contacts list to the printer end.

### Use the Contacts in PC-Fax

1. Open the PC-Fax software and the "Pantum will send Fax" interface appears.
2. Click Show Contacts and the Contacts interface pops up on the right. Connect the printer to the computer and click Read to read the local Contacts list on the printer.

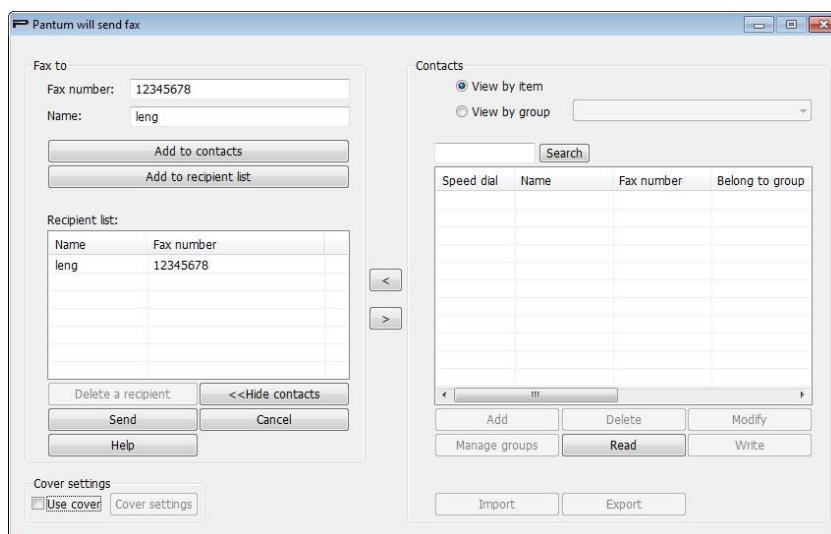

3. Use the Search function to select Fax numbers you want to use, and click "<" to add the Fax numbers from Contacts to the Recipient List.

4. Click Send to start sending the Fax.

#### Use Cover in PC-Fax

If you want to use a Fax cover page, you can use the following steps to set the Cover Settings.

1. Open the PC-Fax software and the "Pantum will send Fax" interface appears.
2. Check Use Cover at the bottom left corner and click Cover Settings to enter the Cover Settings interface.

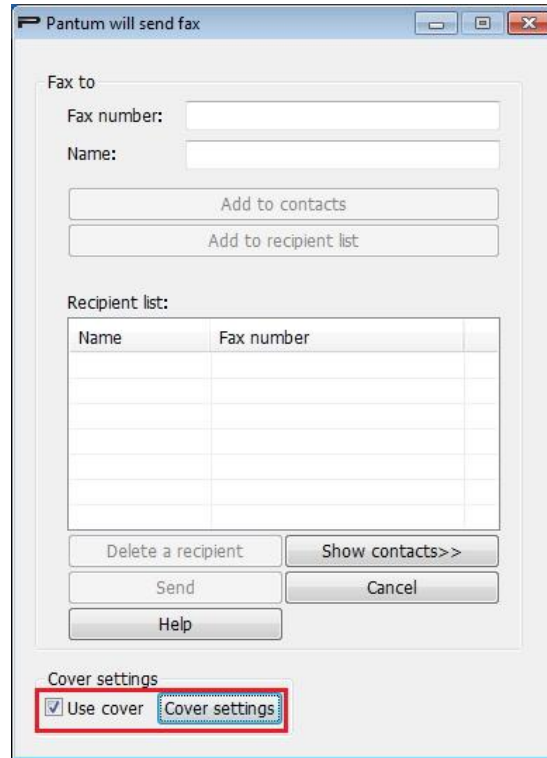

3. You can set the cover Style and the Basic information on right of the Cover Settings interface, and preview the cover on the left.

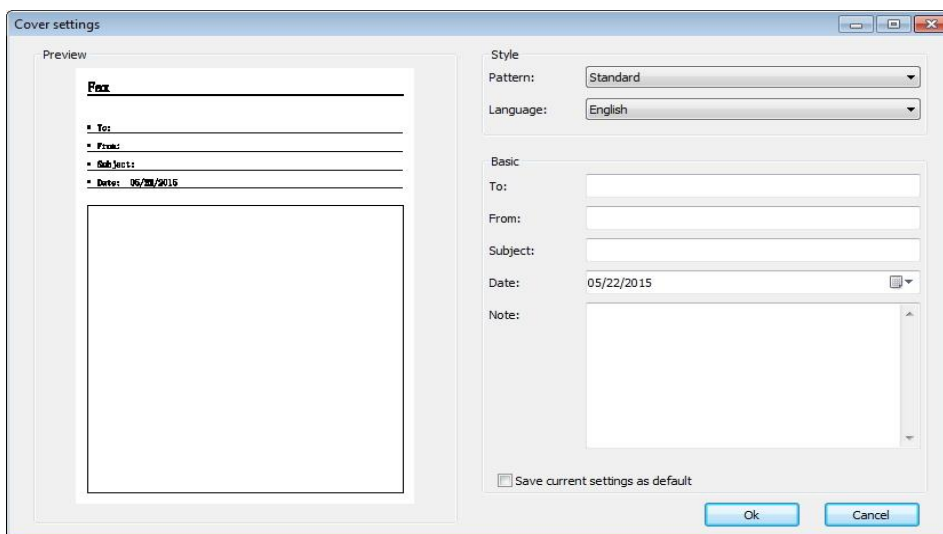

4. When you complete the setup, click the OK button to save the cover.

# 12. Routine Maintenance

## 12.1. Cleaning the Printer

 **Note:** • Please use mild detergents.

Please clean the printer in accordance with the following steps:

1. Turn off the main power switch and unplug the power cord, USB cable, phone cord and the network cable.

**M6200/M6500 Series**

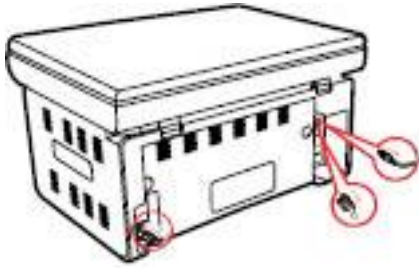

**M6550/M6600 Series**

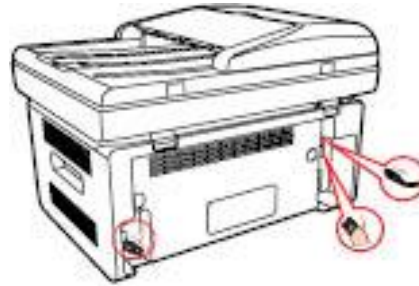

2. Use a soft cloth to wipe the outside of the printer and remove the dust .

**M6200/M6500 Series**



**M6550/M6600 Series**



3. Raise the cover and gently wipe the platen glass with a soft cloth.

**M6200/M6500 Series**

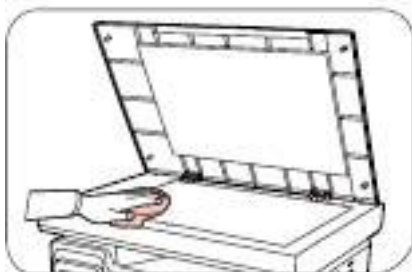

**M6550/M6600 Series**

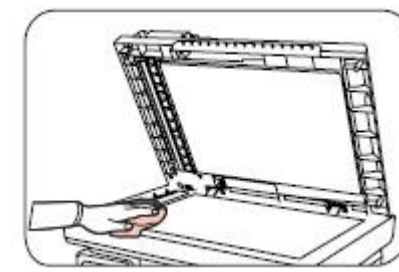

4. Raise the scanning platform until it is locked.

**M6200/M6500 Series**



**M6550/M6600 Series**



5. Open the output bin by the upper right ridge of the concave section.

**M6200/M6500 Series**



**M6550/M6600 Series**



6. Remove the laser toner cartridge along the guides.

**M6200/M6500 Series**

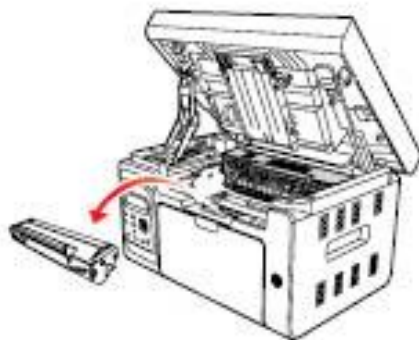

**M6550/M6600 Series**





## Warning

Some parts of the printer are still hot within a short time after use. When opening the front cover or rear cover to clean the parts inside the printer, please do not touch the parts in the shaded area as shown in the following picture, so as to avoid burns.

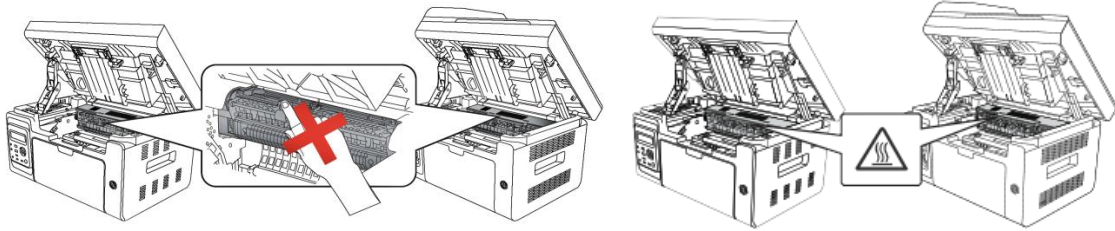

**Note:** • When removing the laser toner cartridge, put the cartridge in a protective bag or wrap it with thick paper to avoid direct light damaging the photosensitive drum.

7. Gently wipe the dustproof mirror of laser scanning surface with a cotton swab or a dry and lint-free soft cloth with a little alcohol.

### M6200/M6500 Series

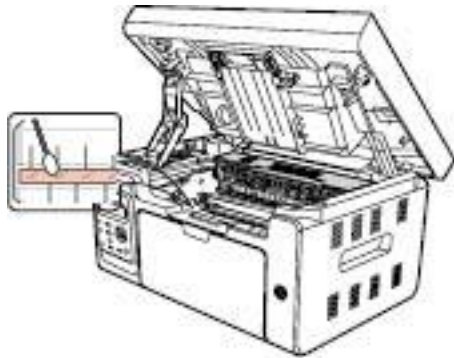

### M6550/M6600 Series

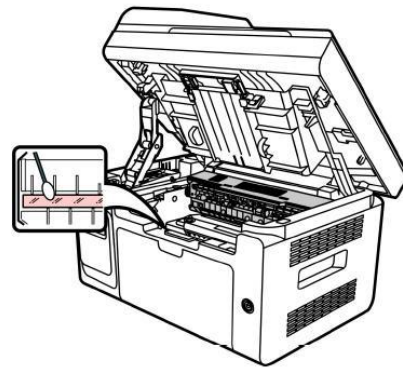

8. Clean the inside of the printer by using a dry and lint-free cloth to gently wipe the shaded area as shown in the picture below.

### M6200/M6500 Series



### M6550/M6600 Series

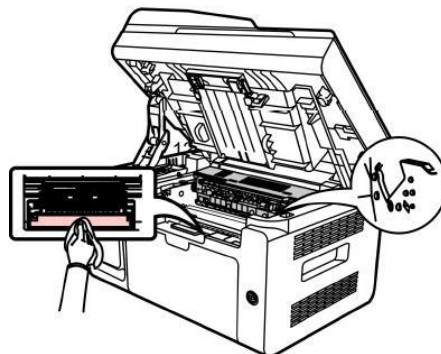

---

 **Note:** For ADF machine, you need to regularly clear scraps. Please use a soft cloth to wipe the location shown in the figure.

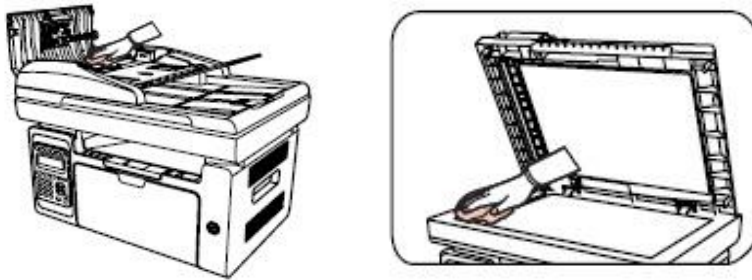

---

## 12.2. Maintenance of Laser Toner Cartridge

### 12.2.1. Use and Maintenance of Laser Toner Cartridge

For better print quality, please use the original Pantum laser toner cartridge.

---

 **Note:** when using the laser toner cartridge, please pay attention to the following:

- Unless used immediately, otherwise, do not remove the laser toner cartridge from the package.
  - Do not refill the laser toner cartridge without authorization. Otherwise, the resulting damage is not included in the printer warranty.
  - Please store the laser toner cartridge under a cool and dry environment.
  - Toner inside the laser toner cartridge is combustible. Please do not put the laser toner cartridge near any source of ignition, so as to avoid causing a fire.
  - When removing or disassembling the laser toner cartridge, please pay attention to the toner leakage problem. In case of the toner leakage resulting in that the toner contacts with your skin or splashes into your eyes and mouth, please immediately wash with clear water, and consult a doctor immediately if you feel unwell.
  - When placing the laser toner cartridge, please keep it away from the area reachable by children.
- 

### 12.2.2. Service Life of the Laser Toner Cartridge

Service life of the laser toner cartridge depends on the amount of toner that print jobs require. When the LCD screen prompts that the toner is exhausted, it indicates that the cartridge life is expiring or has expired. To ensure the print quality, please timely replace with new laser cartridge.

### 12.2.3. Replace Laser Toner Cartridge

 **Note:** Before replacing the laser toner cartridge, please pay attention to the following:

- The laser toner cartridge surface may contain toner. Please remove it carefully to avoid spilling.
- Put the removed laser toner cartridge on a piece of paper to avoid the toner from accidentally spilling.
- After removing the protective cover, please immediately install the laser toner cartridge into the printer, so as to avoid photosensitive drum damage caused by exposing to too much direct sunlight or indoor light.
- While installing the laser toner cartridge, do not touch the surface of the photosensitive drum so as not to scratch it.

Replacement steps are as follows:

1. Turn off the printer and raise the scanning platform until it is locked.

**M6200/M6500 Series**



**M6550/M6600 Series**



2. Open the output bin by the upper right ridge of the concave section.

**M6200/M6500 Series**



**M6550/M6600 Series**



3. Remove the exhausted cartridge along the guides.

---

**M6200/M6500 Series**

**M6550/M6600 Series**

---

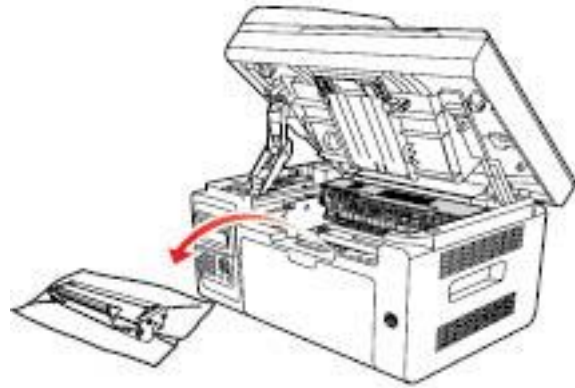
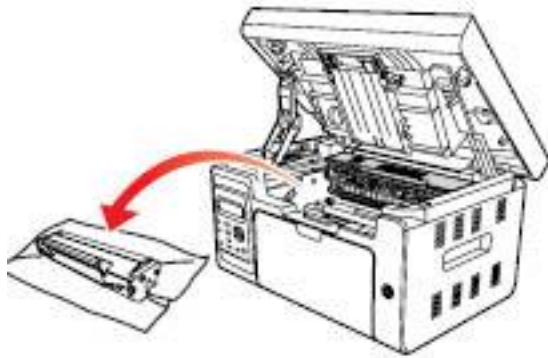

4. Open the package of a new laser toner cartridge, hold the handle of the cartridge and gently shake around 5 to 6 times, so as to make the toner evenly distributed inside the cartridge.

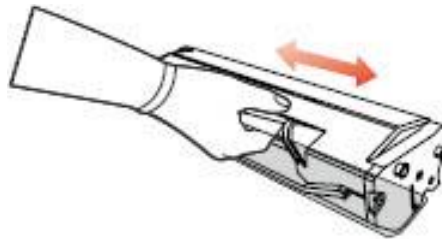

5. Remove the cartridge protector (blister cover), insert the cartridge along the guides into the printer, then push it firmly along the direction of the arrow until you hear a "click" assuring you that the cartridge is fully inserted.

---

**M6200/M6500 Series**

**M6550/M6600 Series**

---





---

 **Note:** • Check whether there is any seal before installing the laser toner cartridge into the printer; if there is any, please tear off the seal and then install the cartridge.

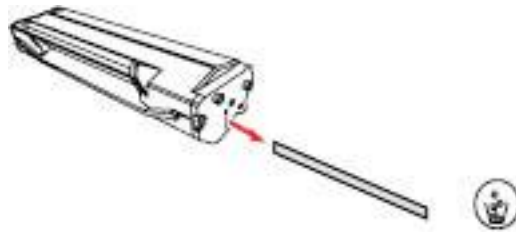

6. Cover the output bin and close the scanning platform.

---

**M6200/M6500 Series**

**M6550/M6600 Series**

---

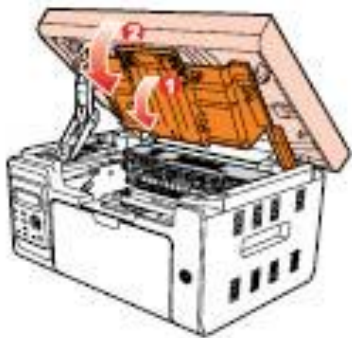

7. Restart the printer, and use the control panel to print an information page.

# 13. Troubleshooting

Please read this section carefully. It can help you solve common malfunctions in the printing process. If the problems appeared cannot be solved, please timely contact Pantum Aftersales Service Center.

Prior to handling common trouble, first check that:

- Whether the power cord is connected correctly and the printer is powered on.
- Whether all protective parts are removed.
- Whether the laser toner cartridge is correctly installed.
- Whether the output bin is fully closed.
- Whether the paper is correctly loaded into the tray.
- Whether the interface cable is correctly connected between the printer and the computer.
- Whether the correct printer driver is selected and installed properly.
- Whether the computer port is properly configured and is connected to the proper printer port.

## 13.1. Clearing Jammed Paper

 **Note:** • Remove the jammed paper in accordance with the following steps, close the upper cover and tidy the paper in the tray, then the printer will automatically resume printing. If the printer cannot automatically start printing, please press the button on the control panel.

If the printer still does not start printing, please check whether all the jammed paper inside the printer are cleared.

If you can not remove the jammed paper yourself, please contact your local Pantum Authorized Repair Center or send the printer to the nearest Pantum Authorized Service Center for repair.

Please follow the following steps to clear the jammed paper if you are prompted of a paper jam by the LCD.

1. Raise the scanning platform until it is locked.

**M6200/M6500 Series**

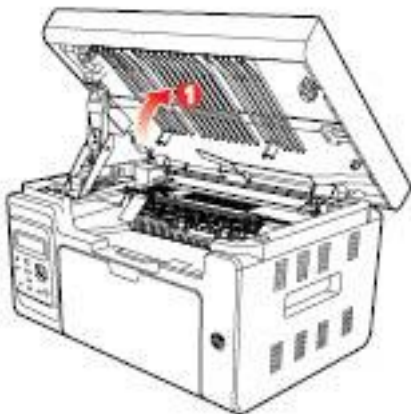

**M6550/M6600 Series**



2. Open the output bin by the upper right ridge of the concave section.

**M6200/M6500 Series**



**M6550/M6600 Series**



3. Remove the laser toner cartridge along the guides.

**M6200/M6500 Series**

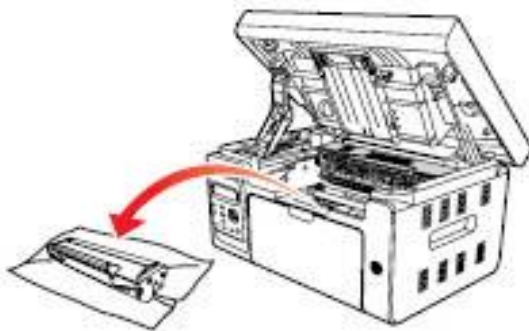

**M6550/M6600 Series**

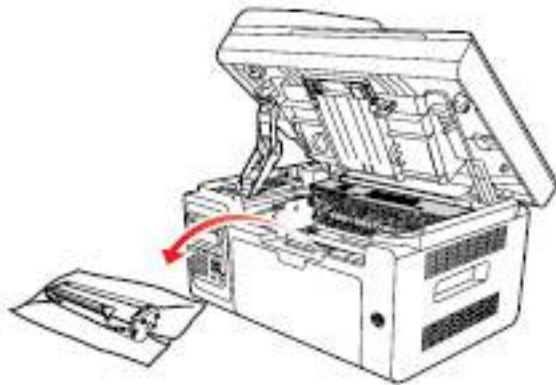

4. Gently draw the jammed paper out along the paper output direction.

**M6200/M6500 Series**

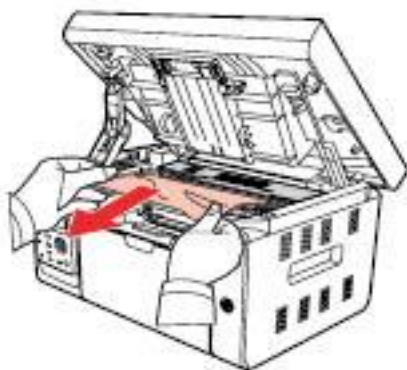

**M6550/M6600 Series**



5. After removing the jammed paper, insert the laser toner cartridge into the printer along the guides until you hear a "click" assuring you that the cartridge is fully inserted.

---

**M6200/M6500 Series**

**M6550/M6600 Series**

---



6. Neatly put the paper in the tray , and do not carry out the next print until the indicator light resumes print-ready status.

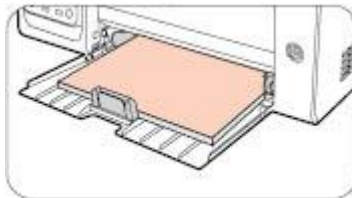

7. If you can not remove the jammed paper yourself, please contact your local Pantum Authorized Repair Center or send the printer to the nearest Pantum Authorized Service Center for repair.

## 13.2. Error Message

<b>Error message</b>	<b>Cause</b>	<b>Measure</b>
Close Output Bin	The paper bin is not fully closed.	Close Output Bin.
No Laser Toner Cartridge Detected	The laser toner cartridge is installed incorrectly or laser toner cartridge is damaged.	The laser toner cartridge is installed correctly or new laser toner cartridge is replaced.
Toner Low	Cartridge toner is low	Replace New Laser Toner Cartridge
The toner cartridge life has expired	Cartridge toner is exhausted.	Replace New Laser Toner Cartridge
Feed jam	The print paper is loaded incorrectly. The paper is outside of the specification range.	Please correctly load the print paper.
Printer paper jam	The print paper is loaded incorrectly.	Please correctly load the print paper.
Scanner is Busy	With other scan jobs.	Please cancel the current scan job or wait for the completion of other scan jobs.
Scan failed	Scanner internal failure.	Please contact Pantum Customer Service.
No paper in ADF	If you have selected ADF as the scan source, this message appears when you start a copy or scan job without loading paper in the ADF.	Please correctly load the print paper.

 **Note:** • If the problem persists, please contact the customer service center. See the Three Guarantees certificate for contact details.

## 13.3. Common Troubleshooting

### 13.3.1. Common Trouble

Trouble Type	Trouble	Cause	Solution
Problems in printing	Poor print quality	See <a href="#">13.3.2. Image Defects.</a>	See <a href="#">13.3.2. Image Defects.</a>
	Failed to copy	The scanner is damaged.	Please contact Pantum Customer Service.
Problems in copying	Copy Image Abnormal	<ul style="list-style-type: none"> <li>• The scanner is dirty or defective.</li> <li>• The laser toner cartridge is dirty or damaged.</li> </ul>	<ul style="list-style-type: none"> <li>• Clean the scanner.</li> <li>• Clean the laser toner cartridge or replace it with a new one.</li> </ul>
		<ul style="list-style-type: none"> <li>• Power cord of the device is not properly connected.</li> <li>• Data cable of the device is not properly connected.</li> <li>• The print driver is installed incorrectly.</li> <li>• The printer selected is not proper for printing.</li> <li>• The LCD screen prompts error messages.</li> </ul>	<ul style="list-style-type: none"> <li>• Ensure proper connection of the power cord.</li> <li>• Ensure proper connection of the data cable.</li> <li>• Properly install the printer driver.</li> <li>• Select the proper printer.</li> </ul>
Printer Problems	The printer does not work	<ul style="list-style-type: none"> <li>• Power cord of the device is not properly connected.</li> <li>• Data cable of the device is not properly connected.</li> <li>• The print driver is installed incorrectly.</li> <li>• The printer selected is not proper for printing.</li> <li>• The LCD screen prompts error messages.</li> </ul>	<ul style="list-style-type: none"> <li>• Ensure proper connection of the power cord.</li> <li>• Ensure proper connection of the data cable.</li> <li>• Properly install the printer driver.</li> <li>• Select the proper printer.</li> </ul>
	Online printing does not work	<ul style="list-style-type: none"> <li>• Data cable of the device is not properly connected.</li> <li>• The printer driver is installed incorrectly.</li> <li>• Printer internal failure.</li> </ul>	<ul style="list-style-type: none"> <li>• Ensure proper connection of the data cable.</li> <li>• Reinstall the printer driver.</li> </ul>
Problems in scanning	Scanning error	<ul style="list-style-type: none"> <li>• Data cable of the device is not properly connected.</li> <li>• The scan driver is installed incorrectly.</li> <li>• The LCD screen prompts error messages.</li> </ul>	<ul style="list-style-type: none"> <li>• Ensure proper connection of the data cable.</li> <li>• Reinstall the scan driver.</li> </ul>

---

Paper feed failure

- The print media is loaded incorrectly.
- The print media is beyond the usage specification range.
- The feed roller is dirty.

- Please correctly load the print media. If you use special print media for printing, please print with the manual feeder tray.
- Please use the print media within the specification range.
- Clean the feed roller.

---

Problems in Handling Paper

Paper Jam

- Too much paper in the tray.
- The print media is beyond the usage specification range.
- There is foreign matter in the feed channel.
- The feed roller is dirty.
- Internal parts failure.

- Remove excess paper from the tray. If you print on special print media, please use the manual feeder tray.
- Make sure to use the paper that meets specifications.
- If you print on special print media, please use the manual feeder tray.
- Clean the feed channel.
- Clean the feed roller.

---

Print with multipage fed in

- Excessive static electricity on the print media.
- The print media is damp or sticks together.
- Internal parts failure.





- Re-separate the print media to eliminate some static electricity. It is suggested that you use the recommended print media.
- Re-separate the print media or use new print media.

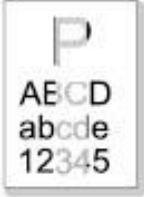

**Note:** • If the problem persists, please contact the customer service center. See the Three Guarantees certificate for contact details.

---

### 13.3.2. Image Defects

Trouble	Cause	Solution
	<ul style="list-style-type: none"> <li>• Toner is low.</li> <li>• The print media does not meet usage specification, such as the media is damp or too rough.</li> <li>• The resolution in the print program is set too low, concentration setting is too low, or toner saving mode is ticked.</li> <li>• The laser toner cartridge is damaged.</li> </ul>	<ul style="list-style-type: none"> <li>• Please properly use the print media within the specification range.</li> <li>• Set the print resolution, concentration, or cancel ticked toner saving mode in the program.</li> </ul>
	<ul style="list-style-type: none"> <li>• The laser toner cartridge is dirty or leaks toner.</li> <li>• The laser toner cartridge is damaged.</li> <li>• The print media that does not meet usage specification is used. For example, the media is damp or too rough.</li> <li>• The feed channel is dirty.</li> <li>• If toner spots appear when copying and scanning, the platen glass may be dirty.</li> <li>• The scanner is dirty or damaged.</li> </ul>	<ul style="list-style-type: none"> <li>• Please use the print media within the specification range.</li> <li>• Clean the feed channel.</li> <li>• Clean the platen glass.</li> </ul>
	<ul style="list-style-type: none"> <li>• The print media that does not meet usage specification is used. For example, the media is damp or too rough.</li> <li>• The feed channel is dirty.</li> <li>• The internal part of the laser toner cartridge is damaged.</li> <li>• The reflective glass of the laser inside the printer is dirty.</li> <li>• The scanner is damaged.</li> </ul>	<ul style="list-style-type: none"> <li>• Please use the print media within the specification range.</li> <li>• Clean the feed channel.</li> <li>• Clean the reflective glass of the laser.</li> </ul>
	<ul style="list-style-type: none"> <li>• The print media that does not meet usage specification is used. For example, the media is damp or too rough.</li> <li>• The inside of the printer is dirty.</li> <li>• The laser toner cartridge is damaged.</li> <li>• The internal part of the printer is damaged.</li> </ul>	<ul style="list-style-type: none"> <li>• Please use the print media within the specification range.</li> <li>• Clean the inside of the printer.</li> </ul>



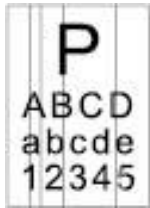

Black vertical stripes

- The laser toner cartridge is dirty.
- The internal part of the laser toner cartridge is damaged.
- The reflective glass of the laser inside the printer is dirty.
- The feed channel is dirty.
- If black vertical stripes appear when copying or scanning, the scanner or the platen glass may be dirty.
- Scanner Light bulb has smudges.
- The scanner is damaged.

- Clean the reflective glass of the laser at the back of the printer.
- Clean the feed channel at the back of the printer.
- Clean the scanner or the platen glass.



Black background (gray background)

- The print media that does not meet usage specification is used. For example, the media is damp or too rough.
- The laser toner cartridge is dirty.
- The internal part of the laser toner cartridge is damaged.
- The feed channel is dirty.
- The transfer voltage inside the printer is abnormal.
- Scanning exposure.
- If black background or gray background appears when copying and scanning, the platen glass may be dirty.

- Please use the print media within the specification range.
- Clean the feed channel inside the printer.
- Please close the cover on the manuscript, and then carry out copying and scanning.
- Clean the platen glass.

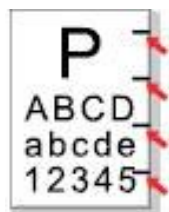

Cyclical traces appear

- The laser toner cartridge is dirty.
- The internal part of the laser toner cartridge is damaged.
- The fuser component is damaged.

- Clean the laser toner cartridge or replace it with a new one.
- Please contact Pantum Customer Service to repair and replace the fuser component.



Skewed pages

- The print media is loaded incorrectly.
- The feed channel of the printer is dirty.

- Ensure correct loading the print media.
- Clean the feed channel inside the printer.

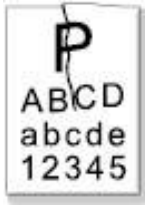

Wrinkled paper

- The print media is loaded incorrectly.
- The print media does not meet the usage specification.
- The feed channel inside the printer is dirty.
- The fuser component of the printer is damaged.

- Ensure correct loading the print media.
- Please use the print media within the specification range for printing.
- Clean the feed channel inside the printer.



The back of the printout is dirty

- The laser toner cartridge is dirty.
- The transfer roller inside the printer is dirty.
- The transfer voltage inside the printer is abnormal.

- Clean the laser toner cartridge or replace it with a new one.
- Clean the internal transfer components of the printer.



Whole page dark

- The laser toner cartridge is installed incorrectly.
- The internal part of the laser toner cartridge is damaged.
- Abnormal charge inside the printer; the laser toner cartridge is not charged.
- If all-black image appear when copying and scanning, maybe it is scanning exposure, and the cover on the manuscript is not properly closed.
- The scanner is damaged.

- Ensure to install the cartridge correctly.
- Please first close the cover on the manuscript, and then carry out copying and scanning.



The toner does not adhere to the paper

- The print media that does not meet usage specification, such as the media is damp or too rough.
- The inside of the printer is dirty.
- The laser toner cartridge is damaged.
- The internal part of the printer is damaged.

- Please use the print media within the specification range.
- Clean the inside of the printer.

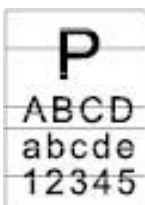

Horizontal stripes

- The laser toner cartridge is incorrectly installed.
- The laser toner cartridge might be damaged.
- The internal part of the printer is damaged.

- Ensure to install the cartridge correctly.



**Note:** • The faults above can be mitigated by cleaning or replacing the cartridge. If the problem persists, please contact the customer service center. See the Three Guarantees certificate for contact details.

## 14. Menu Structure

With the help of menu structure of this printer on the panel menu, you may know and set various functions. The steps of printing are as follows:

1. Press "Menu" to enter the menu setting interface.
2. Press "▲" or "▼" to select "Info. report".
3. Press "OK" and then "▲" or "▼" to select "Prt Menu Frame".
4. Press "OK" to print.

# 15. Product Specifications

 **Note:** • Specification values vary slightly from printers with different models with different functions, and product specifications vary from different countries and regions.  
 • These values are based on the initial data. For more information about the latest specifications, please visit: [www.pantum.com](http://www.pantum.com).

## 15.1. Overview of the Specifications

Product Size (W*D*H)	M6200/M6500 Series: 417mm*305mm*244mm
	M6550/M6600 Series: 417mm*305mm*301mm
Product Weight	M6200/M6500 Series: about 7.5Kg (No wrappage, with random cartridges)
	M6550/M6600 Series: 8.5Kg (No wrappage, with random cartridges)
Print Environment	Preferred Temperature Range for Printing: 10-32°C (50°F-90°F)
	Preferred Moisture Range for Printing: 20% - 80%
Power Voltage	110V Model:
	AC100~127V (±10%); 50Hz/60Hz; 6A
	220V Model:
	AC220~240V (-15%,+10%), 50Hz/60Hz; 3A
Noise	Print: ≤54dB
	Standby: ≤30dB
Power Consumption	Print: Average 370W, Maximum 750W
	Standby: ≤45W
	Networked standby: ≤3.5W
Operating System	Microsoft Windows Server2008/Server2012/XP/Vista/Windows7/Windows8/Windows8.1/Windows10 /Windows11 (32/64 Bit)
	macOS 10.9/10.10/10.11/10.12/10.13/10.14/10.15/11.6/12.1
	Linux (with limitation on version)
	iOS/Android (with limitation on version)
	NeoKylin (Loongson) (with limitation on version)

Communication interface	Hi-speed USB 2.0
	100Base-Tx Ethernet (Applicable for network model)
	Wi-Fi 802.11b/g/n (Applicable for Wi-Fi model only)
Processor	600MHz
Memory	128MB/256MB

## 15.2. Print Specifications

Print Speed	M6200/M6500 Series: (A4 20/22ppm)/(Letter 21/23ppm)
	M6550/M6600 Series: (A4 22ppm)/(Letter 23ppm)
Print Time of First Page	<7.8sec
Print Language	GDI

## 15.3. Copy Specifications

Copy Speed	22cpm (A4)/23cpm (Letter)
FCOT	Flatbed <10 seconds
	ADF <12 seconds
Maximum Pages for Successive Print	99 pages
Zoom Ratio	25%~400%
Other Copy Functions	ID copy, Receipt copy, N-up copy, Clone copy

## 15.4. Scan Specifications

Scan Type	Flatbed+ADF (M6550 Series)
Maximum Scan Size	Flatbed: 216×297mm
	ADF: 216×356 mm
Chromoscan	Yes
Scan Output Function	Scan to E-mail, PC, FTP

## 15.5. Fax Specifications (For M6600 Series models only)

Fax Type	Black-and-white
Modem Speed	33.6Kbps
Fax Memory	650 pages
Encoding	MH/MR/MMR
Compatibility	ITU-T SG3/ECM
Other Fax Functions	PC-FAX (Send), Fax Filtering, Group Sending, Fax Forwarding, Speed Dial, Group Dial, Delay Sending, Auto Redial, Auto Receive, Auto Shrink, Mobile Fax
Environment	Not supported in the following environment: ADSL, ISDN



**Note:** • Please pay attention to contents below when VOIP line is used.

If Fax is sent or received abnormally due to disturbance on telephone line, try to improve Fax delivery rate with modes below:

1. Switching to VOIP compatibility mode by setting control panel.

Please set according to the operation below:

1) Press “menu” key.

2) Press “▲” or “▼” to enter “Fax setting” option and then press “OK”.

3) Press “▲” or “▼” to enter “compatibility” and then press “OK”.

4) Press “▲” or “▼” to select “VOIP” to switch to VOIP compatibility mode.

2. Resend Fax at leisure time.

3. Consult VOIP supplier if the network setting for Fax transmission can be optimized.

**PANTUM**